

elementi logici

logic elements



- Ampia gamma
Wide range
- Dimensioni ridotte
Small dimensions
- Possibilità di montaggio su squadretta di supporto
Mountable on bracket
- Attacchi filettati M5, G1/8" o raccordi automatici per tubo $\varnothing 4$
M5, G1/8" threaded ports or push-in fittings for $\varnothing 4$ tube



Materiali

Corpo: alluminio 11S

Molle: INOX

Guarnizioni: NBR

Parti interne: ottone OT58

Materials

Body: aluminium 11S

Springs: stainless steel

Seals: NBR

Internal parts: brass OT58

Diametro nominale <i>Nominal orifice</i>	2.5 mm
Portata nominale a 6 bar <i>Nominal flow rate at 6 bar</i>	100 Nl/min
Temperatura di esercizio <i>Temperature range</i>	max +60°C
Pressione di esercizio <i>Working pressure</i>	2 ... 10 bar 0.2 ... 1 MPa
Fluido <i>Fluid</i>	Aria filtrata 50 μ con o senza lubrificazione <i>50μ filtered, lubricated or non lubricated air</i>

08.021.4 - OR PER LOGICA

elemento OR, raccordi automatici per tubo $\varnothing 4$, fissabile su squadretta
OR element, push-in fittings for $\varnothing 4$ tube, mountable on bracket

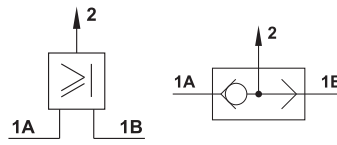

08.025.4 - AND PER LOGICA

elemento AND, raccordi automatici per tubo $\varnothing 4$, fissabile su squadretta
AND element, push-in fittings for $\varnothing 4$ tube, mountable on bracket

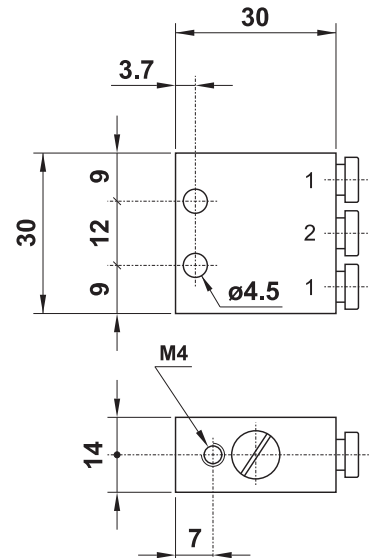
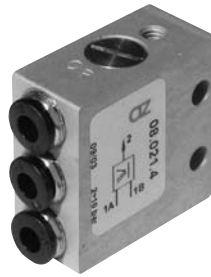
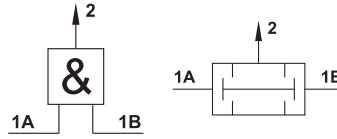

08.022.4 - OR SINGOLO M5

elemento OR, attacchi filettati M5
OR element, M5 threaded ports

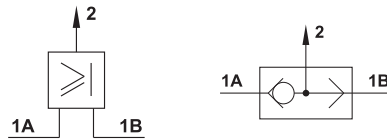

08.026.4 - AND SINGOLO M5

elemento AND, attacchi filettati M5
AND element, M5 threaded ports

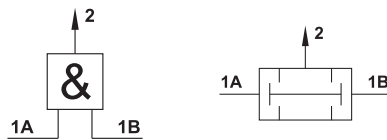

08.023.4 - OR SINGOLO 1/8

elemento OR, attacchi filettati G1/8"
OR element, G1/8" threaded ports

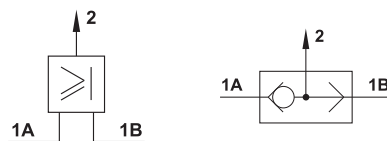

08.027.4 - AND SINGOLO 1/8

elemento AND, attacchi filettati G1/8"
AND element, G1/8" threaded ports

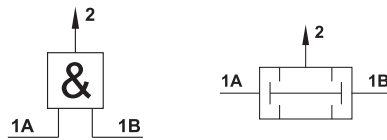

Modello Model	A	B	C
08.022.4	5.2	19.6	M5
08.026.4	5.2	19.6	M5
08.023.4	7	16	G1/8"
08.027.4	7	16	G1/8"

