

SERIE

**E**

**CILINDRO COMPATTO GUIDATO**  
**GUIDED COMPACT CYLINDER**

  
**ARTEC**<sup>®</sup>  
PNEUMATIC COMPONENTS

### CARATTERISTICHE TECNICHE - TECHNICAL CHARACTERISTICS

<b>Pressione di esercizio</b> <i>Working pressure</i>	1 ÷ 10 bar (doppio effetto - <i>double acting</i> )
<b>Temperatura di esercizio</b> <i>Working temperature</i>	0 ÷ +80°C (-20°C con aria secca - <i>with dry air</i> )
<b>Versioni - Versions</b>	doppio effetto - <i>double acting</i>
<b>Alesaggi - Bores</b>	∅ 16 - 20 - 25 - 32 - 40 - 50 - 63
<b>Corse - Strokes</b>	vedere tabelle corse standard - <i>see standard stroke tables</i>
<b>Fluido - Fluid</b>	aria compressa filtrata, non lubrificata - <i>compressed filtered, non lubricated air</i>

### CARATTERISTICHE COSTRUTTIVE - CONSTRUCTIVE CHARACTERISTICS

① <b>Piastra - Plate</b>	acciaio nichelato - <i>nickel steel</i>
② <b>Stelo di Guida - Guide Rod</b>	acciaio C45 cromato - <i>C45 chromed steel</i>
③ <b>Raschiatore - Wiper</b>	NBR
④ <b>Boccola - Bush</b>	bronzo sinterizzato - <i>sintered bronze</i>
⑤ <b>Corpo - Body</b>	alluminio anodizzato - <i>anodized aluminum</i>
⑥ <b>Guarnizione stelo - Rod Seal</b>	poliuretano - <i>polyurethane</i>
⑦ <b>Testa Anteriore - Front Cover</b>	alluminio anodizzato - <i>anodized aluminum</i>
⑧ <b>Paracolpo - Bumper</b>	NBR
⑨ <b>Stelo - Rod</b>	acciaio C45 cromato - <i>C45 chromed steel</i>
⑩ <b>Pistone - Piston</b>	alluminio - <i>aluminum</i>
⑪ <b>Guarnizione Pistone - Piston Seal</b>	NBR
⑫ <b>Magnete - Magnet</b>	plastroferrite
⑬ <b>Testa posteriore - Rear Cover</b>	alluminio anodizzato - <i>anodized aluminum</i>

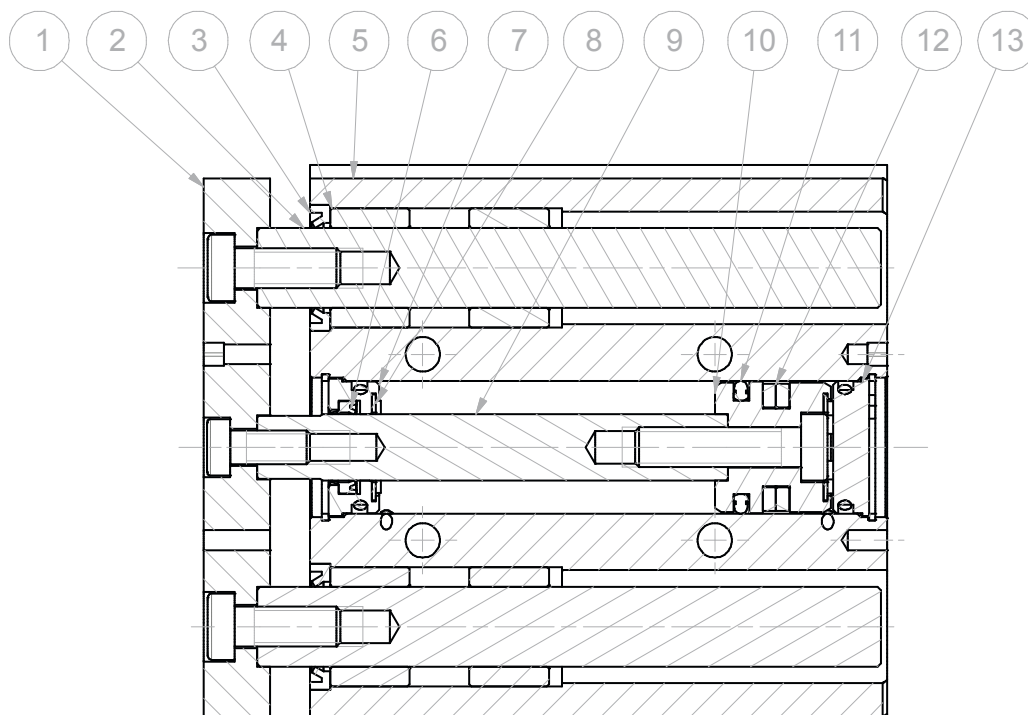

## CHIAVE DI CODIFICA

### KEY CODE

E		D		M		0		5		0		.		0		3		0		.		G		S	
						<b>ALESAGGIO - BORE (Ø)</b>						<b>CORSA - STROKE (mm)</b>						<b>OPZIONE - OPTION</b>							
						016 - 020 - 025 - 032 040 - 050 - 063						vedere tabelle corse std see std stroke table						EX ATEX  II 2GD c T4							
						<b>VERSIONE - VERSION</b>												<b>OPZIONE - OPTION</b>							
						con boccole in bronzo with bronze bushes												steli-viti-seeger inox .5 SS rod screws-retaining ring							
						S con cuscinetti a ricircolo di sfere with recirculating ball bearings																			
						<b>VERSIONE - VERSION</b>												<b>OPZIONE - OPTION</b>							
						M magnetico magnetic												senza ammortizzo pneumatico without pneumatic cushioning							
						non magnetico non-magnetic												.W con ammortizzo pneumatico with pneumatic cushioning							
						<b>VERSIONE - VERSION</b>												<b>GUARNIZIONI - SEALS</b>							
						D doppio effetto double acting												GS guarnizioni standard standard seals							
						<b>SERIE - SERIES</b>												VR guarnizione stelo per alte temperature high temperature rod seal							
						E tubo profilato con cave per sensori profile tube with slots for sensors												VA tutte le guarnizioni per alte temperature all seals for high temperature							

SERIE  
**E**

### ESECUZIONI A RICHIESTA - ON REQUEST

Doppia piastra - Double plate

Stelo prolungato (FB) - Extended rod (FB)

ATEX II 2GD c T4

### FORZE TEORICHE DI TRAZIONE (P=6bar)

### THEORETICAL FORCES OF TRACTION (P=6bar)

		Ø	016	020	025	032	040	050	063
EDM	SPINTA THRUST	[N]	121	188	295	483	754	1178	1870
	TRAZIONE TRACTION	[N]	90	141	247	415	686	1057	1750

**ESEMPI DI FISSAGGIO**

**FIXING EXAMPLE**

MONTAGGIO SUPERIORE  
TOP MOUNTING

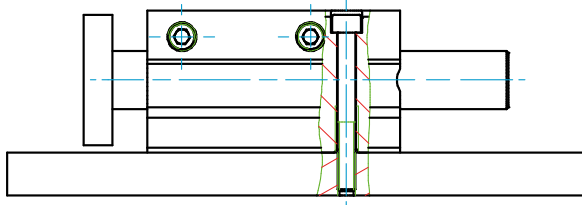

MONTAGGIO INFERIORE  
BOTTOM MOUNTING

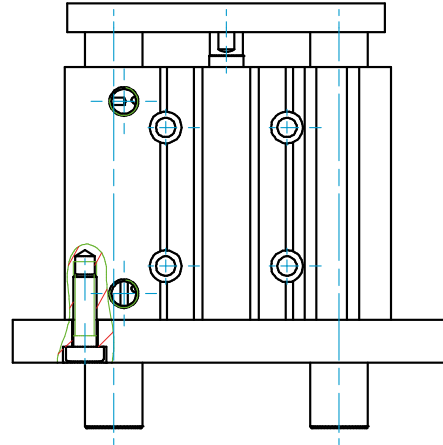

MONTAGGIO LATERALE  
SIDE MOUNTING

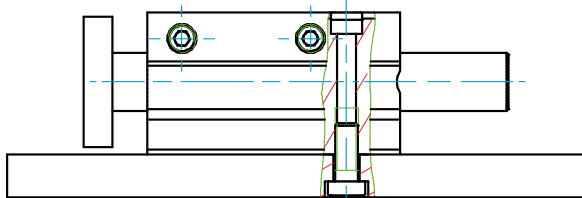

MONTAGGIO TRAMITE DADO NELLA CAVA A "T"  
NUT INSIDE T-SLOT MOUNTING

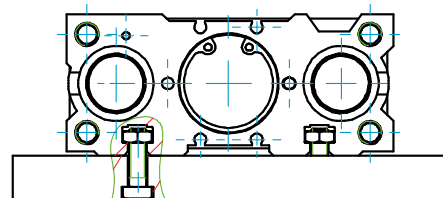

!!! Il fissaggio deve avvenire mediante viti amagnetiche  
!!! The fixing must be with non-magnetic screws

SERIE

E

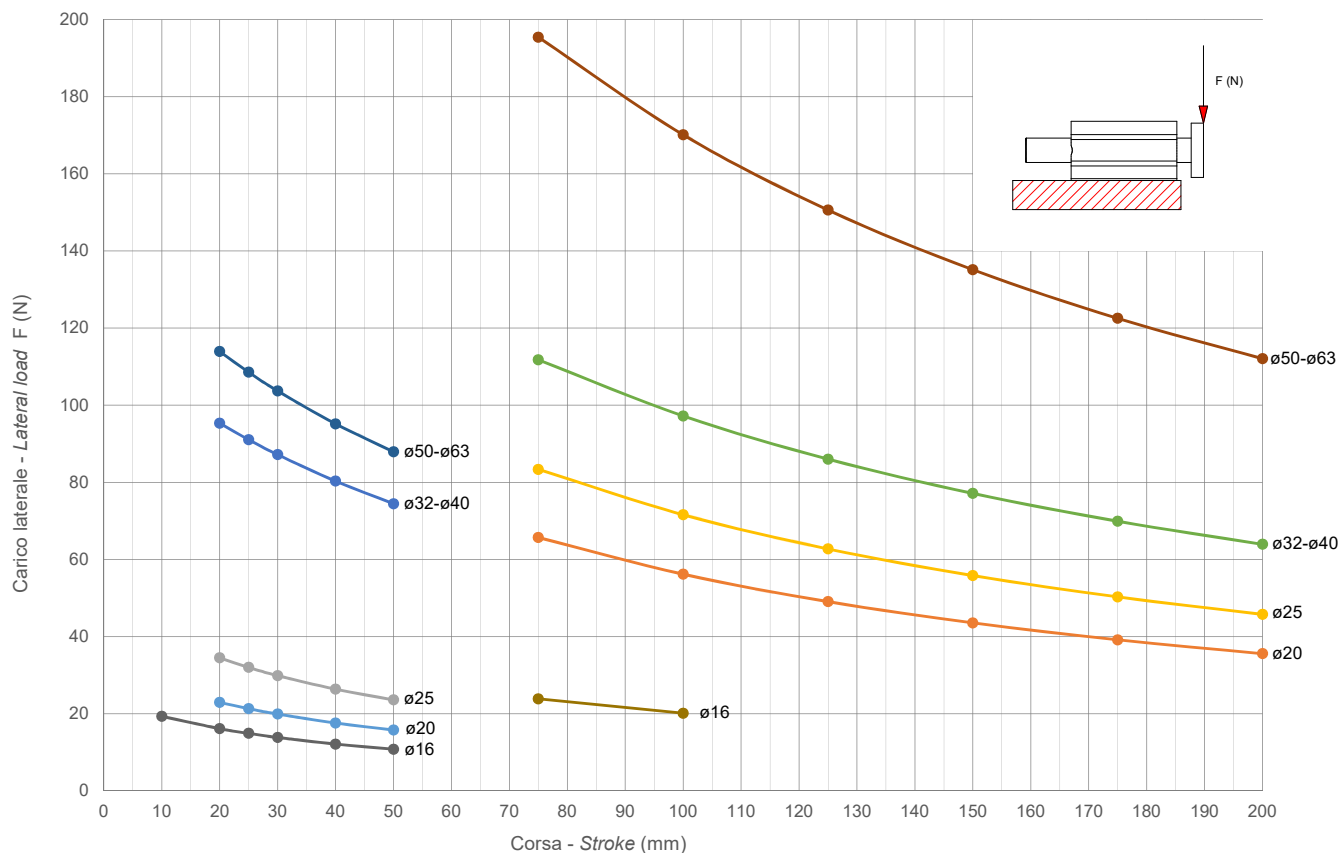
**DIAGRAMMA TEORICO CARICO AMMISSIBILE**
**THEORETICAL ALLOWABLE LOAD**

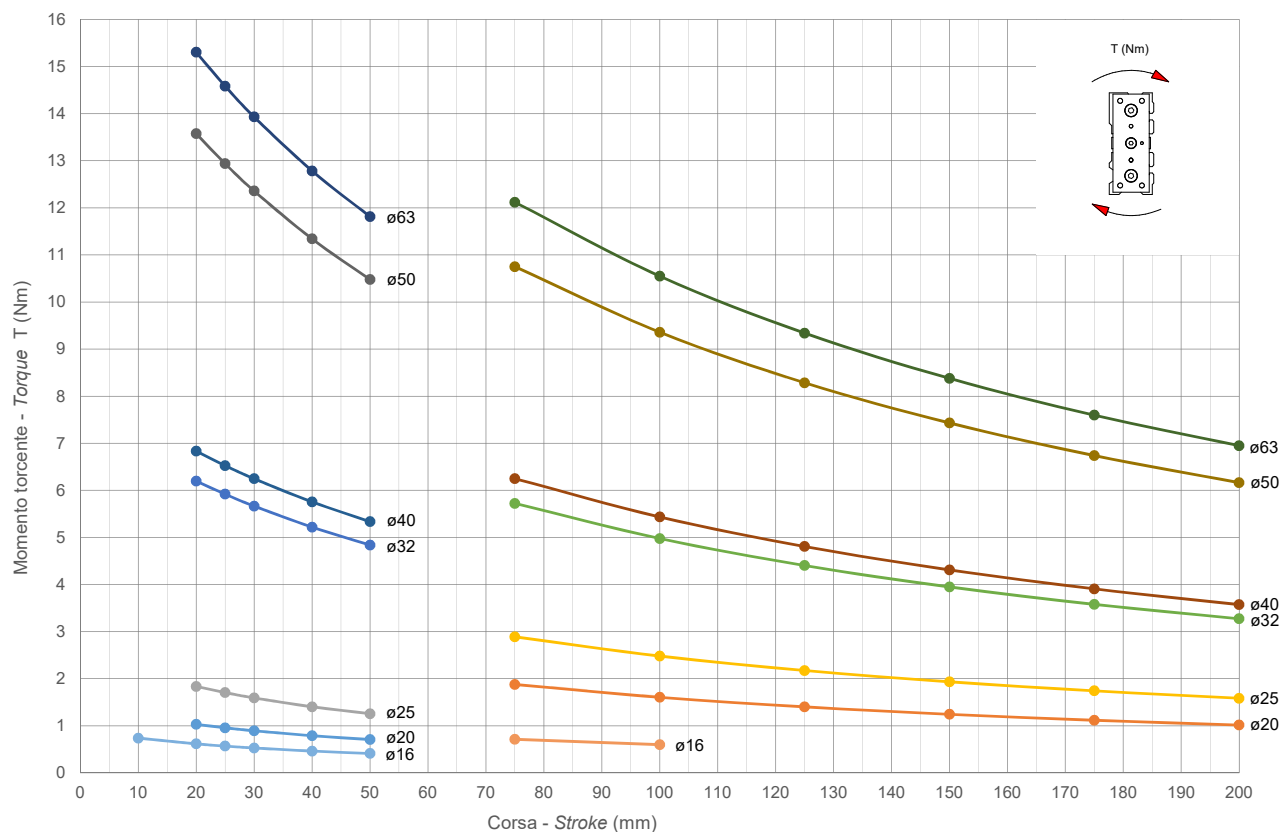
 SERIE  
E

**DIAGRAMMA TEORICO COPPIA AMMISSIBILE**
**THEORETICAL ALLOWABLE TORQUE**

**COMPATTO GUIDATO D.E.M.**

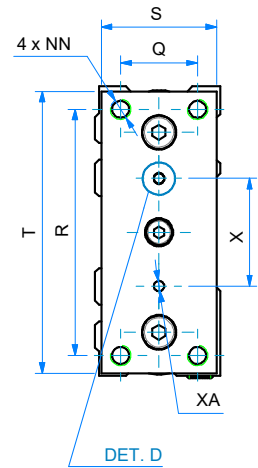
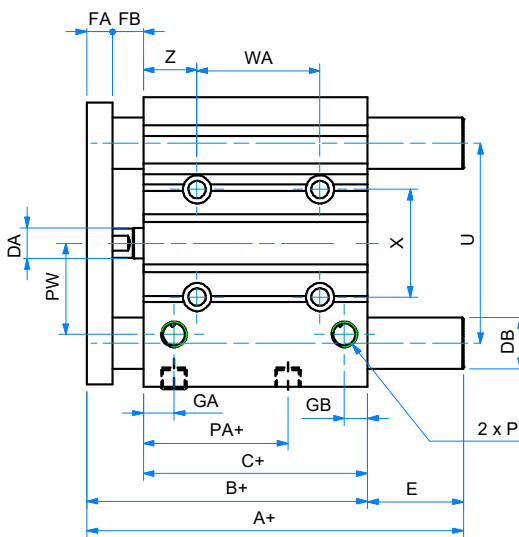
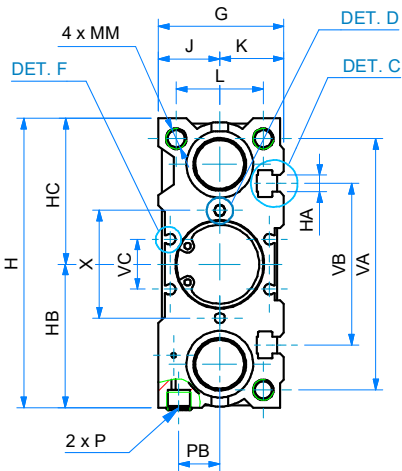
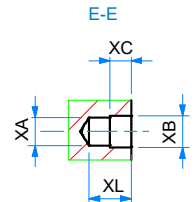
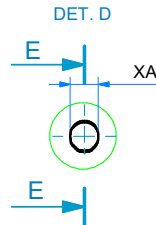
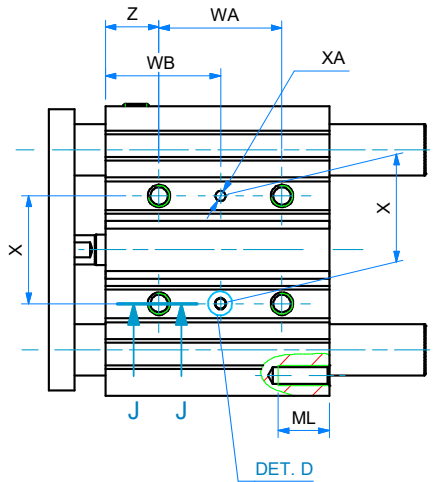
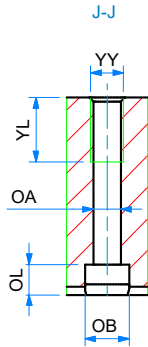
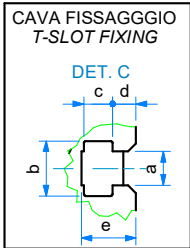
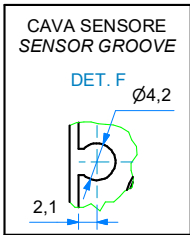
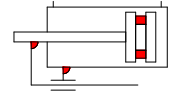
**D.A.M. GUIDED COMPACT**



Ø	CORSE STANDARD - STANDARD STROKES
016	10 - 20 - 30 - 40 - 50 - 75 - 100
020	20 - 30 - 40 - 50 - 75 - 100 - 125 - 150 - 175 - 200
025	20 - 30 - 40 - 50 - 75 - 100 - 125 - 150 - 175 - 200
032	25 - 50 - 75 - 100 - 125 - 150 - 175 - 200
040	25 - 50 - 75 - 100 - 125 - 150 - 175 - 200
050	25 - 50 - 75 - 100 - 125 - 150 - 175 - 200
063	25 - 50 - 75 - 100 - 125 - 150 - 175 - 200

!!!: Le corse intermedie vengono realizzate con il corpo della corsa standard superiore e con distanziale interno per limitarne la corsa a quella richiesta.  
Intermediate strokes are made with the profile of the standard superior stroke and with an internal spacer which limits the stroke to the required one.

## DIMENSIONI - DIMENSIONS

## CON BOCCHE IN BRONZO - WITH BRONZE BUSH

	16	20	25	32	40	50	63
ø							
A+ (corsa-stroke 0÷50)	42	53	53,5	97	91	106,5	106,5
A+ (corsa-stroke 75÷200)	64,5	84,5	85	102	102	118	118
B+	46	53	53,5	59,5	66	72	77
C+	33	37	37,5	37,5	44	44	49
ø DA	8	10	10	12	12	16	16
ø DB	10	12	16	20	20	25	25
E (corsa-stroke 0÷50)	0	0	0	37,5	31	34,5	29,5
E (corsa-stroke 75÷200)	18,5	31,5	31,5	42,5	36	46	41
FA	8	10	10	10	10	15	15
FB	5	6	6	12	12	13	13
G	30,5	36,8	42,8	49	55	65	79
GA	11	11,5	11,5	12	15	15	15,5
GB	8	9	10	9	12	12	13,5
H	64	84	94	113	121	149	163
HA	M4	M5	M5	M6	M6	M8	M10
HB	32,5	41,5	46,5	56	60	74	81
HC	32	42,5	47,5	57	61	75	82
J	15	18	21	24	27	32	39
K	15,5	18,8	21,8	25	28	33	40
L	22	24	30	34	40	46	58
MM	M5	M5	M6	M8	M8	M10	M10
ML	12	13	15	16	16	20	22
NN	M5	M5	M6	M8	M8	M10	M10
OA	4,2	5,2	5,2	6,5	6,5	8,5	8,5
OB	8	9,5	9,5	11	11	14	14
OL	4,5	5,5	5,5	7,5	7,5	9	9
P	M5	G1/8	G1/8	G1/8	G1/8	G1/4	G1/4
PA+	15	13,5	12,5	6,5	13	9	13
PB	10	11	14	16	18	21,5	28
PW	19	25	30	35,5	39,5	47	58
Q	16	18	26	30	30	40	50
R	54	70	78	96	104	130	130
S	25	30	40	45	45	60	70
T	62	81	91	110	118	146	158
U	46	54	64	78	86	110	124
VA	56	72	82	98	106	130	142
VB	38	44	50	63	72	92	110
VC	10,5	12,5	15	19,5	25	33	34
WA (corsa-stroke 0÷30)	24	24	24	24	24	24	28
WA (corsa-stroke 40÷100)	44	44	44	48	48	48	52
WA (corsa-stroke 125÷200)	110	120	120	124	124	124	128
WB (corsa-stroke 0÷30)	17	29	29	33	34	36	38
WB (corsa-stroke 40÷100)	27	39	39	45	46	48	50
WB (corsa-stroke 125÷200)	60	77	77	83	84	86	88
X ± 0,02	24	28	34	42	50	66	80
ø XA H9	3	3	4	4	4	5	5
XB	3,5	3,5	4,5	4,5	4,5	6	6
XC	3	3	3	3	3	4	4
XL	6	6	6	6	6	8	8
YY	M5	M6	M6	M8	M8	M10	M10
YL	10	12	12	16	16	20	22
Z	5	17	17	21	22	24	24
a	4,4	5,4	5,4	6,5	6,5	8,5	11
b	7,4	8,4	8,4	10,5	10,5	13,5	17,8
c	3,7	4,5	4,5	5,5	5,5	7,5	10
d	3,5	3,6	3,8	4,5	5	5,5	8
e	6,7	8,6	9	10,5	10,5	14,5	19,5

SERIE

E

**COMPATTO GUIDATO D.E.M. CON CUSCINETTI A RICIRCOLO DI SFERE**

**D.A.M. GUIDED COMPACT WITH RECIRCULATING BALL BEARINGS**

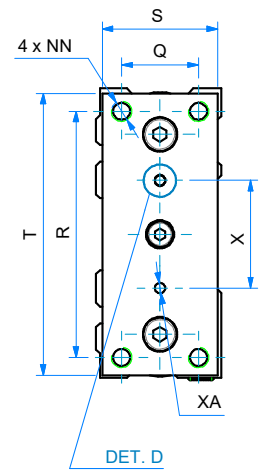
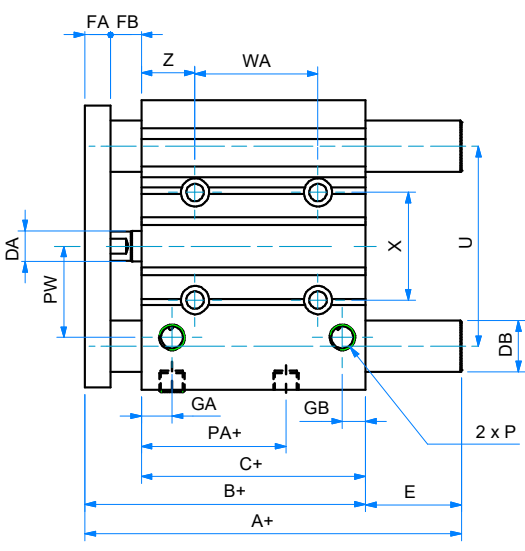
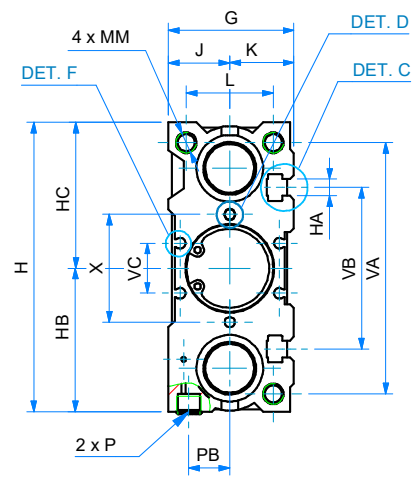
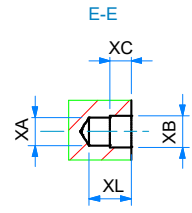
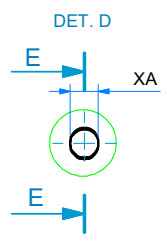
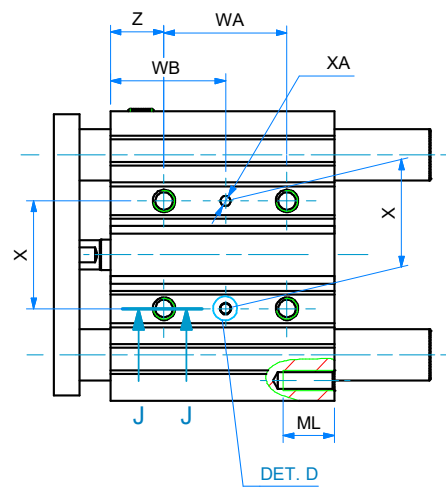
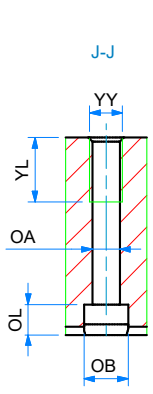
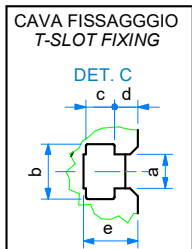
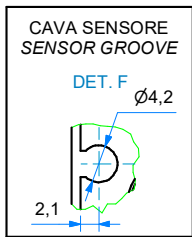
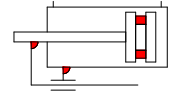

0	CORSE STANDARD - STANDARD STROKES
016	10 - 20 - 30 - 40 - 50 - 75 - 100
020	20 - 30 - 40 - 50 - 75 - 100 - 125 - 150 - 175 - 200
025	20 - 30 - 40 - 50 - 75 - 100 - 125 - 150 - 175 - 200
032	25 - 50 - 75 - 100 - 125 - 150 - 175 - 200
040	25 - 50 - 75 - 100 - 125 - 150 - 175 - 200
050	25 - 50 - 75 - 100 - 125 - 150 - 175 - 200
063	25 - 50 - 75 - 100 - 125 - 150 - 175 - 200

!!!: Le corse intermedie vengono realizzate con il corpo della corsa standard superiore e con distanziale interno per limitarne la corsa a quella richiesta.  
 Intermediate strokes are made with the profile of the standard superior stroke and with an internal spacer which limits the stroke to the required one.



DIMENSIONI - DIMENSIONS	CON CUSCINETTI A RICIRCOLO DI SFERE - WITH RECIRCULATING BALL BEARINGS						
	16	20	25	32	40	50	63
A+ (corsa-stroke 0÷30)	49	63	69,5	-	-	-	-
A+ (corsa-stroke 40÷100)	65	80	86	-	-	-	-
A+ (corsa-stroke 125÷200)	-	104	104,5	-	-	-	-
A+ (corsa-stroke 0÷50)	-	-	-	81	81	93	93
A+ (corsa-stroke 75÷100)	-	-	-	98	98	114	114
A+ (corsa-stroke 125÷200)	-	-	-	118	118	134	134
B+	46	53	53,5	59,5	66	72	77
C+	33	37	37,5	37,5	44	44	49
ø DA	8	10	10	12	12	16	16
ø DB	8	12	14	20	20	25	25
E (corsa-stroke 0÷30)	3	10	16	-	-	-	-
E (corsa-stroke 40÷100)	19	27	32,5	-	-	-	-
E (corsa-stroke 125÷200)	-	51	51	-	-	-	-
E (corsa-stroke 0÷50)	-	-	-	21,5	15	21	16
E (corsa-stroke 75÷100)	-	-	-	38,5	32	42	37
E (corsa-stroke 125÷200)	-	-	-	58,5	52	62	57
FA	8	10	10	10	10	15	15
FB	5	6	6	12	12	13	13
G	30,5	36,8	42,8	49	55	65	79
GA	11	11,5	11,5	12	15	15	15,5
GB	8	9	10	9	12	12	13,5
H	64	84	94	113	121	149	163
HA	M4	M5	M5	M6	M6	M8	M10
HB	32,5	41,5	46,5	56	60	74	81
HC	32	42,5	47,5	57	61	75	82
J	15	18	21	24	27	32	39
K	15,5	18,8	21,8	25	28	33	40
L	22	24	30	34	40	46	58
MM	M5	M5	M6	M8	M8	M10	M10
ML	12	13	15	16	16	20	22
NN	M5	M5	M6	M8	M8	M10	M10
OA	4,2	5,2	5,2	6,5	6,5	8,5	8,5
OB	8	9,5	9,5	11	11	14	14
OL	4,5	5,5	5,5	7,5	7,5	9	9
P	M5	G1/8	G1/8	G1/8	G1/8	G1/4	G1/4
PA+	15	13,5	12,5	6,5	13	9	13
PB	10	11	14	16	18	21,5	28
PW	19	25	30	35,5	39,5	47	58
Q	16	18	26	30	30	40	50
R	54	70	78	96	104	130	130
S	25	30	40	45	45	60	70
T	62	81	91	110	118	146	158
U	46	54	64	78	86	110	124
VA	56	72	82	98	106	130	142
VB	38	44	50	63	72	92	110
VC	10,5	12,5	15	19,5	25	33	34
WA (corsa-stroke 0÷30)	24	24	24	24	24	24	28
WA (corsa-stroke 40÷100)	44	44	44	48	48	48	52
WA (corsa-stroke 125÷200)	110	120	120	124	124	124	128
WB (corsa-stroke 0÷30)	17	29	29	33	34	36	38
WB (corsa-stroke 40÷100)	27	39	39	45	46	48	50
WB (corsa-stroke 125÷200)	60	77	77	83	84	86	88
X ± 0,02	24	28	34	42	50	66	80
ø XA H9	3	3	4	4	4	5	5
XB	3,5	3,5	4,5	4,5	4,5	6	6
XC	3	3	3	3	3	4	4
XL	6	6	6	6	6	8	8
YY	M5	M6	M6	M8	M8	M10	M10
YL	10	12	12	16	16	20	22
Z	5	17	17	21	22	24	24
a	4,4	5,4	5,4	6,5	6,5	8,5	11
b	7,4	8,4	8,4	10,5	10,5	13,5	17,8
c	3,7	4,5	4,5	5,5	5,5	7,5	10
d	3,5	3,6	3,8	4,5	5	5,5	8
e	6,7	8,6	9	10,5	10,5	14,5	19,5

**COMPATTO GUIDATO D.E.M. CON BOCCOLE IN BRONZO AMMORTIZZATO**

**D.A.M. GUIDED COMPACT WITH BRONZE BUSHES CUSHIONED**

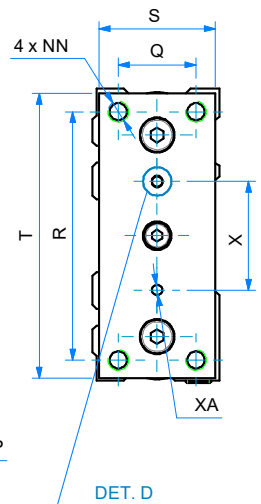
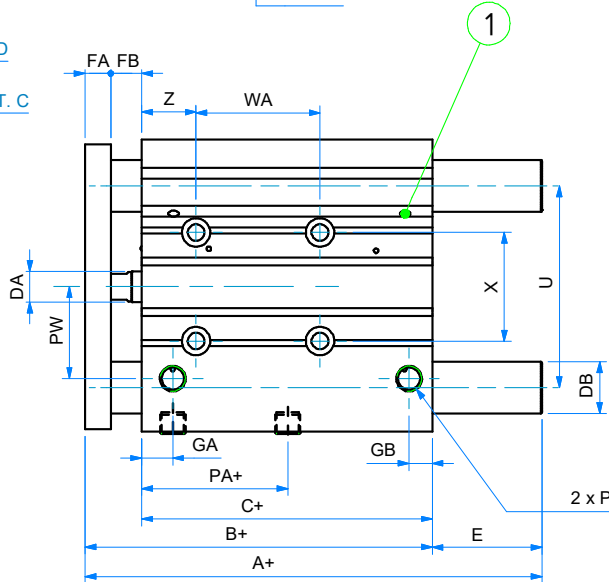
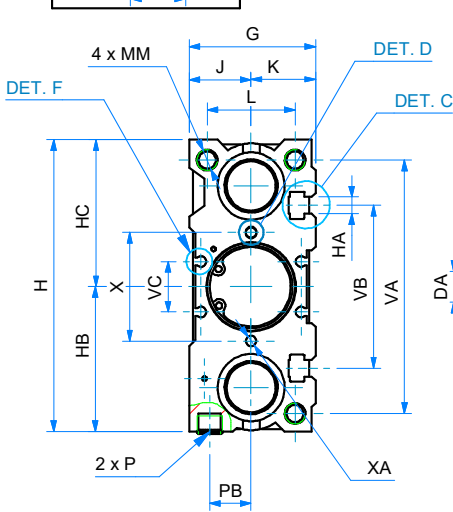
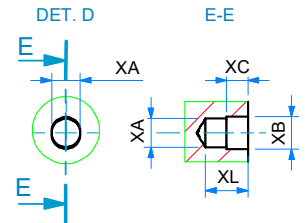
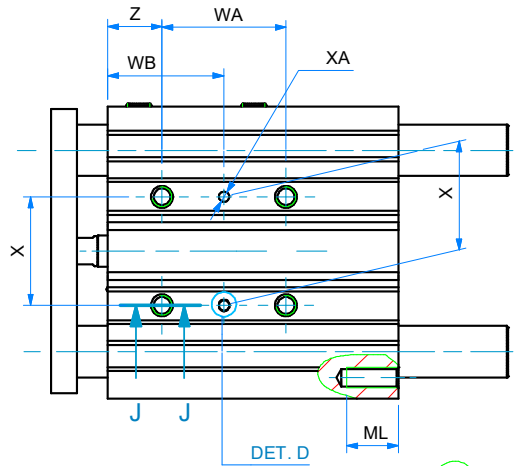
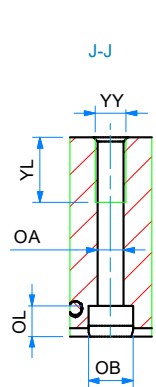
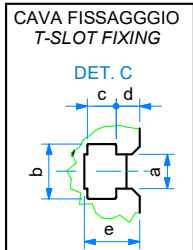
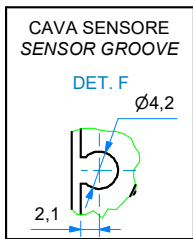
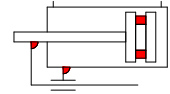

① Vite regolazione ammortizzo - Cushioning adjustment screw

Ø	CORSE STANDARD - STANDARD STROKES
016	20 - 25 - 30 - 40 - 50 - 75 - 100
020	20 - 25 - 30 - 40 - 50 - 75 - 100 - 125 - 150 - 175 - 200
025	20 - 25 - 30 - 40 - 50 - 75 - 100 - 125 - 150 - 175 - 200
032	25 - 50 - 75 - 100 - 125 - 150 - 175 - 200
040	25 - 50 - 75 - 100 - 125 - 150 - 175 - 200
050	25 - 50 - 75 - 100 - 125 - 150 - 175 - 200
063	25 - 50 - 75 - 100 - 125 - 150 - 175 - 200

!!!: Le corse intermedie della versione ammortizzata non sono realizzabili (per ulteriori informazioni contattare l'ufficio commerciale)

Intermediate strokes of versions with cushioning are not possible (for further information, please contact our sales department)

**DIMENSIONI - DIMENSIONS**
**CON BOCCOLE IN BRONZO - WITH BRONZE BUSH**

<b>ø</b>	<b>16</b>	<b>20</b>	<b>25</b>	<b>32</b>	<b>40</b>	<b>50</b>	<b>63</b>
<b>A+ (corsa-stroke 0÷25)</b>	71	78	78,5	97	97	106,5	106,5
<b>A+ (corsa-stroke &gt;25÷50)</b>	71	86,5	87	127	127	131,5	131,5
<b>A+ (corsa-stroke 75÷200)</b>	71	84,5	85	102	102	118	118
<b>B+</b>	71	78	78,5	84,5	91	97	102
<b>C+</b>	58	62	62,5	62,5	69	69	74
<b>øDA</b>	8	10	10	12	12	16	16
<b>øDB</b>	10	12	16	20	20	25	25
<b>E (corsa-stroke 0÷25)</b>	0	0	0	12,5	6	9,5	4,5
<b>E+ (corsa-stroke &gt;25÷50)</b>	0	8,5	8,5	42,5	36	34,5	29,5
<b>E (corsa-stroke 75÷200)</b>	0	6,5	6,5	17,5	11	21	16
<b>FA</b>	8	10	10	10	10	15	15
<b>FB</b>	5	6	6	12	12	13	13
<b>G</b>	30,5	36,8	42,8	49	55	65	79
<b>GA</b>	11	11,5	11,5	12	15	15	15,5
<b>GB</b>	8	9	10	9	12	12	13,5
<b>H</b>	64	84	94	113	121	149	163
<b>HA</b>	M4	M5	M5	M6	M6	M8	M10
<b>HB</b>	32,5	41,5	46,5	56	60	74	81
<b>HC</b>	32	42,5	47,5	57	61	75	82
<b>J</b>	15	18	21	24	27	32	39
<b>K</b>	15,5	18,8	21,8	25	28	33	40
<b>L</b>	22	24	30	34	40	46	58
<b>MM</b>	M5	M5	M6	M8	M8	M10	M10
<b>ML</b>	12	13	15	16	16	20	22
<b>NN</b>	M5	M5	M6	M8	M8	M10	M10
<b>OA</b>	4,2	5,2	5,2	6,5	6,5	8,5	8,5
<b>OB</b>	8	9,5	9,5	11	11	14	14
<b>OL</b>	4,5	5,5	5,5	7,5	7,5	9	9
<b>P</b>	M5	G1/8	G1/8	G1/8	G1/8	G1/4	G1/4
<b>PA+</b>	40	38,5	37,5	31,5	38	34	38
<b>PB</b>	10	10,5	13,5	16	18	21,5	28
<b>PW</b>	19	25	30	35,5	39,5	47	58
<b>Q</b>	16	18	26	30	30	40	50
<b>R</b>	54	70	78	96	104	130	130
<b>S</b>	25	30	40	45	45	60	70
<b>T</b>	62	81	91	110	118	146	158
<b>U</b>	46	54	64	78	86	110	124
<b>VA</b>	56	72	82	98	106	130	142
<b>VB</b>	38	44	50	63	72	92	110
<b>VC</b>	10,5	12,5	15	19,5	25	33	34
<b>WA (corsa-stroke 0÷75)</b>	44	44	44	48	48	48	52
<b>WA (corsa-stroke 100÷175)</b>	110	120	120	124	124	124	128
<b>WA (corsa-stroke 200)</b>	/	200	200	200	200	200	200
<b>WB (corsa-stroke 0÷75)</b>	27	39	39	45	46	48	50
<b>WB (corsa-stroke 100÷175)</b>	60	77	77	83	84	86	88
<b>WB (corsa-stroke 200)</b>	/	117	117	121	122	124	124
<b>X ±0,02</b>	24	28	34	42	50	66	80
<b>øXA H9</b>	3	3	4	4	4	5	5
<b>XB</b>	3,5	3,5	4,5	4,5	4,5	6	6
<b>XC</b>	3	3	3	3	3	4	4
<b>XL</b>	6	6	6	6	6	8	8
<b>YY</b>	M5	M6	M6	M8	M8	M10	M10
<b>YL</b>	10	12	12	16	16	20	22
<b>Z</b>	5	17	17	21	22	24	24
<b>a</b>	4,4	5,4	5,4	6,5	6,5	8,5	11
<b>b</b>	7,4	8,4	8,4	10,5	10,5	13,5	17,8
<b>c</b>	3,7	4,5	4,5	5,5	5,5	7,5	10
<b>d</b>	3,5	3,6	3,8	4,5	5	5,5	8
<b>e</b>	6,7	8,6	9	10,5	10,5	14,5	19,5

 SERIE  
**E**

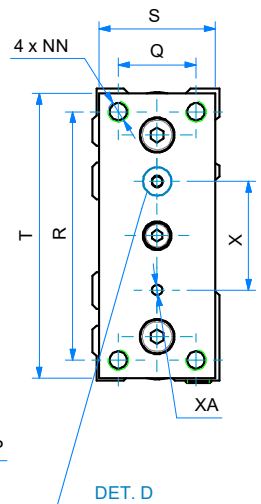
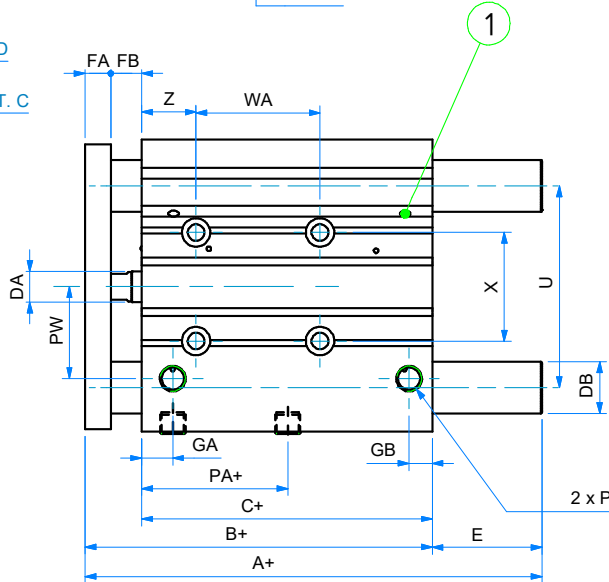
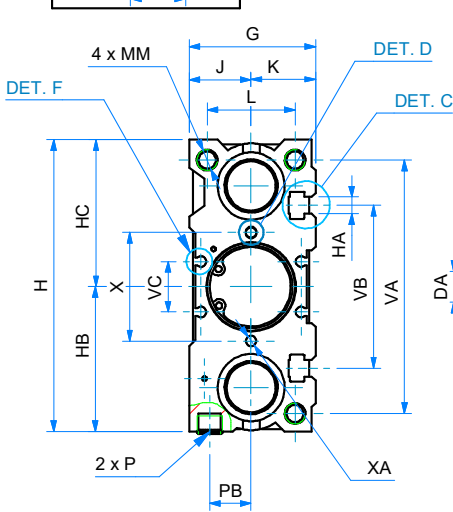
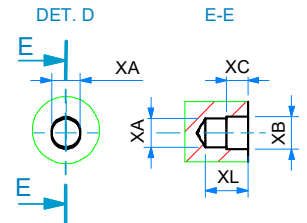
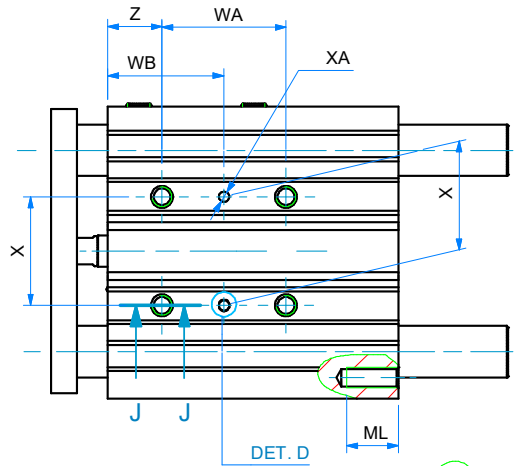
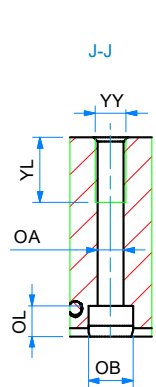
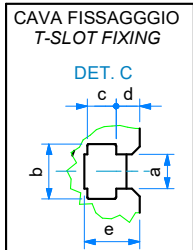
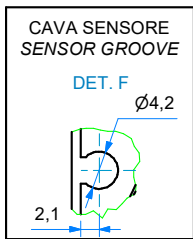
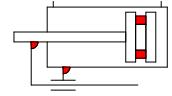
**D.E.M. CON CUSCINETTI A RICIRCOLO DI SFERE AMMORTIZZATO**
**D.A.M. CUSHIONED WITH RECIRCULATING BALL BEARINGS**

① Vite regolazione ammortizzo - Cushioning adjustment screw

$\varnothing$	CORSE STANDARD - STANDARD STROKES
016	20 - 25 - 30 - 40 - 50 - 75 - 100
020	20 - 25 - 30 - 40 - 50 - 75 - 100 - 125 - 150 - 175 - 200
025	20 - 25 - 30 - 40 - 50 - 75 - 100 - 125 - 150 - 175 - 200
032	25 - 50 - 75 - 100 - 125 - 150 - 175 - 200
040	25 - 50 - 75 - 100 - 125 - 150 - 175 - 200
050	25 - 50 - 75 - 100 - 125 - 150 - 175 - 200
063	25 - 50 - 75 - 100 - 125 - 150 - 175 - 200

!!!: Le corse intermedie della versione ammortizzata non sono realizzabili (per ulteriori informazioni contattare l'ufficio commerciale)

Intermediate strokes of versions with cushioning are not possible (for further information, please contact our sales department)

DIMENSIONI - DIMENSIONS		CON CUSCINETTI A RICIRCOLO DI SFERE - WITH RECIRCULATING BALL BEARINGS					
	16	20	25	32	40	50	63
A+ (corsa-stroke 0÷25)	71	95	100,5	84,5	91	97	102
A+ (corsa-stroke 50)	71	80	85,5	123	123	127,5	127,5
A+ (corsa-stroke 75)	71	80	85,5	98	98	114	114
A+ (corsa-stroke 100)	71	99	99,5	115,5	115,5	159	159
A+ (corsa-stroke >125)	-	104	104,5	118	118	134	134
B+	71	78	78,5	84,5	91	97	102
C+	58	62	62,5	62,5	69	69	74
oDA	8	10	10	12	12	16	16
oDB	8	12	14	20	20	25	25
E (corsa-stroke 0÷25)	0	17	22	0	0	0	0
E (corsa-stroke 50)	0	2	7	38,5	32	30,5	25,5
E (corsa-stroke 75)	0	2	7	13,5	7	17	12
E (corsa-stroke 100)	0	21	26	31	24,5	62	57
E (corsa-stroke >125)	-	26	26	33,5	27	37	32
FA	8	10	10	10	10	15	15
FB	5	6	6	12	12	13	13
G	30,5	36,8	42,8	49	55	65	79
GA	11	11,5	11,5	12	15	15	15,5
GB	8	9	10	9	12	12	13,5
H	64	84	94	113	121	149	163
HA	M4	M5	M5	M6	M6	M8	M10
HB	32,5	41,5	46,5	56	60	74	81
HC	32	42,5	47,5	57	61	75	82
J	15	18	21	24	27	32	39
K	15,5	18,8	21,8	25	28	33	40
L	22	24	30	34	40	46	58
MM	M5	M5	M6	M8	M8	M10	M10
ML	12	13	15	16	16	20	22
NN	M5	M5	M6	M8	M8	M10	M10
OA	4,2	5,2	5,2	6,5	6,5	8,5	8,5
OB	8	9,5	9,5	11	11	14	14
OL	4,5	5,5	5,5	7,5	7,5	9	9
P	M5	G1/8	G1/8	G1/8	G1/8	G1/4	G1/4
PA+	40	38,5	37,5	31,5	38	34	38
PB	10	10,5	13,5	16	18	21,5	28
PW	19	25	30	35,5	39,5	47	58
Q	16	18	26	30	30	40	50
R	54	70	78	96	104	130	130
S	25	30	40	45	45	60	70
T	62	81	91	110	118	146	158
U	46	54	64	78	86	110	124
VA	56	72	82	98	106	130	142
VB	38	44	50	63	72	92	110
VC	10,5	12,5	15	19,5	25	33	34
WA (corsa-stroke 0÷75)	44	44	44	48	48	48	52
WA (corsa-stroke 100÷175)	110	120	120	124	124	124	128
WA (corsa-stroke 200)	/	200	200	200	200	200	200
WB (corsa-stroke 0÷75)	27	39	39	45	46	48	50
WB (corsa-stroke 100÷175)	60	77	77	83	84	86	88
WB (corsa-stroke 200)	/	117	117	121	122	124	124
X ±0,02	24	28	34	42	50	66	80
oXA H9	3	3	4	4	4	5	5
XB	3,5	3,5	4,5	4,5	4,5	6	6
XC	3	3	3	3	3	4	4
XL	6	6	6	6	6	8	8
YY	M5	M6	M6	M8	M8	M10	M10
YL	10	12	12	16	16	20	22
Z	5	17	17	21	22	24	24
a	4,4	5,4	5,4	6,5	6,5	8,5	11
b	7,4	8,4	8,4	10,5	10,5	13,5	17,8
c	3,7	4,5	4,5	5,5	5,5	7,5	10
d	3,5	3,6	3,8	4,5	5	5,5	8
e	6,7	8,6	9	10,5	10,5	14,5	19,5