

INSTRUCTION MANUAL

DIGITAL FLOW AND PRESSURE SENSOR



KFP02 Series





Product Safety Instructions

■ This section indicate the levels of risks with the labels of Danger, Warning and Caution.

 Danger	Danger indicates high level of risk, will lead to fatal or serious injuries if not avoided.
 Warning	Warning indicates medium level of risk, it might cause death or serious injuries.
 Caution	Caution indicates low level of risk, it might result in minor injuries, such as scald, electric shock, etc. and the product, equipment and machines might be damaged.

Warning

■ Precautions for use

- ① **Operated within the specified voltage.**
Malfunction or damaged product, electric shock or fire may be resulted by exceeding the specified voltage range.
- ② **Do not exceed the maximum load current.**
It may damage the product.
- ③ **Do not use any load that generates surges.**
Surge protection is present but applying surge voltage repeatedly will ultimately damage the product.
When using with inductive load (such as relay or solenoid), please install a flyback diode across the load (polarity must be observed).
- ④ **Observed the internal voltage drop.**
When used at a specified voltage, if the sensor is functional but the load does not work, please check if the operating voltage of the load meets the following formula.

$$\text{Power Supply} - \text{Internal voltage} > \text{Minimum operating voltage} - \text{drop of sensor} - \text{voltage of load}$$
- ⑤ **Do not operate the product outside the specifications.**
The sensor will be damaged by exceeding the flow rate and working pressure.
- ⑥ **Do not use flammable fluids and/or permeable fluids.**
They may cause fire, explosion or corrosion.

■ Working fluid and working environment

- ① **Do not use in an explosive gas atmosphere.**
The sensor does not have explosion-proof structure, fire, explosion or corrosion can result.
- ② **Do not use near a surge voltage generated area.**
Solenoid lifters, high frequency induction furnaces and motors, etc. can generate high surge voltages, if using near the sensor will cause the internal circuit components to deteriorate and cause damages.
- ③ **Sensors can not withstand lightning strikes.**
The product is CE compliant, but can not resist surge voltage of lightning strikes, take measures to avoid lightening strikes in the system.
- ④ **Do not use in an environment where sensors could be splashed by water or oil.**
Enclosure rating is IP40, please avoid water or oil splashed environment to prevent adversely effects.
- ⑤ **Do not use in an environment subject to large temperature cycling.**
Internal components of the sensor will be affected adversely by large heating/cooling cycles other than ordinary changes in temperature.
- ⑥ **Do not mount the product in locations where it is exposed to radiant heat.**
This could result in damage and/or malfunction.

 **Warning**
■ Wiring Precautions

- ① **Check wire color and terminal number when wiring.**
Incorrect wiring can cause permanent damages to the sensor, check wire color and terminal number against the manual before wiring.
- ② **Avoid repeatedly bending or stretching the lead wire.**
It can cause damage to the sheath, or breakage of the wire.
- ③ **Confirm wiring insulation**
Please avoid poor insulations (and interference from another circuit, poor insulation between terminals, etc.) it can lead to over current being applied to the product, causing damage.
- ④ **Do not route wires and cables together with power or high voltage cables.**
The product may malfunction due to interference or noise and surge voltage from power and high voltage cables.
- ⑤ **Do not short-circuit the load.**
When the load is short-circuited, an error will be displayed. But excess current may cause damage to the sensor.
- ⑥ **Do not connect wire when the power is on.**
It may cause damages to the sensors/equipment/machines.
- ⑦ **RS485 products must be connected the communication wire first.**
To prevent product damage due to short circuit, MUST do RS485 line connection BEFORE power line connection.

■ Installation Precautions

- ① **Ensure the flow direction of the fluid.**
Please follow the flow direction indicator for installation and piping.
- ② **Flush out all dirt and dust by air blow before connect the piping to the sensor.**
- ③ **Do not drop or hit.**
When installation, do not drop, hit or apply excessive shock (100m/s²). Internal damage can cause malfunction even if the housing appears to be undamaged.
- ④ **Do not install multiple products in close proximity.**
The heat generated from each product could cause the temperature to rise and change the characteristics of product or deterioration of the plastic parts. Please set the products 10mm apart from each other.
- ⑤ **Hold the sensor body when installing.**
The tensile strength of the cable is 24.5 N and apply excessive pulling force can cause damage to the sensor.

■ Other Precautions

- ① **After power is supplied, the output will remain off until the display is turned on. Please operate the sensor after the value is shown.**
- ② **Stop the control systems before perform setting changes.**
During the initial flow and pressure setting, the product will switch the output according to the existing settings until the changes are complete.

 **Caution**
■ Installation Precautions

- ① **Please follow the specified tightening torque.**
Over tighten will damage the product.
- ② **Do not mount the sensor in a place that will be used as a foothold.**
The product may damage if sit or step on it accidentally.
- ③ **While installing the KFP02 to the pipe, please apply I.D. 9 mm or more air tube.**

■ Maintenance Precautions

- ① **Do not insert a stick or wire into the piping ports.**
- ② **Do not touch the terminals or connectors when power is on.**

■ Disposal

- ① **Sensors at end-of-life must be disposed of in accordance with E-Waste regulations of the country/region, NOT disposed of with regular garbage.**

Warning

■ Fluid

- ① Check the regulator and flow adjustment valve before introducing the fluid.
If the pressure or flow rate exceeded the specified range, the sensing element may be damaged.
- ② The sensing element cannot measure properly if foreign matter adheres to it.
- ③ On the inlet side, be sure to install an air filter below the filtration level of 10um.

④ Recommended Equipments and Installation

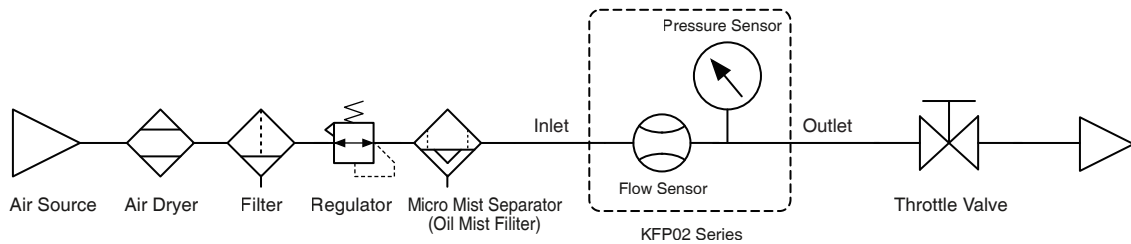

※ NOTE :
Please install a throttle valve on the outlet side of the sensor to prevent errors caused by unstable flow.

Disclaimer

- ① Our warranty applies solely to our product, not to any other damages and injuries which occur by earthquakes, fires, the acts by third party, other matters, acts intentionally, acts accidentally, misuse, or other abnormal conditions that are not the responsible of KITA.
- ② Our warranty applies solely to our product, not to any other additional damages (the loses of business profits, business interruption, etc.) incurred due to using or misusing the product.
- ③ Our warranty excludes any injuries and damages happened by using the product beyond the specified range of catalog or/and not following the instruction manual.

[CONTENTS]

1. Installation Instructions	5
1.1 Piping	5
1.2 Mounting bracket	6
1.3 Wiring	7
1.3.1 NPN output, Analog output and external input	7
1.3.2 PNP output, Analog output and external input	8
1.3.3 NPN output, RS-485 Modbus	9
1.3.4 PNP output, RS-485 Modbus	9
2. How to Use	10
2.1 Names and Functions of Individual Parts	10
2.2 Functions Instructions	11
2.3 Operation Setting	13
3. Modbus RTU Instruction	44
4. Error Code Instruction	46
5. Specifications.....	47
6. Pressure Loss Characteristics	48
7. Thermal Mass Principles of Flow Sensor	48
8. Ordering Information	49
9. Dimensions	50
10. Internal Structure	52

1 Installation

1.1 Piping

Install the pipe by following the arrow indication that shows the air flow direction on the product.

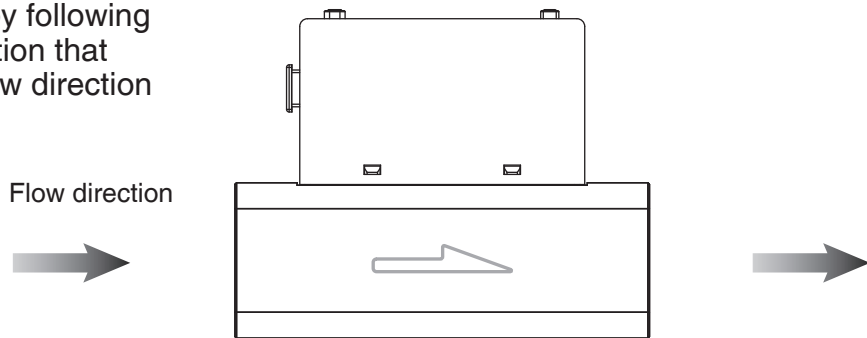

Use straight piping 8cm or longer (I.D. 9 mm or more) to connect the Piping Port (Inlet side). If straight piping is not installed, the accuracy may vary by $\pm 2\%$ F.S..

Avoid sudden changes in the piping size on the inlet side of the product.

Do not release the outlet side piping port of the product directly to the atmosphere without the piping connected.

※ Straight Piping: The pipe is without bending and the cross sectional areas of the pipe keeps the same.

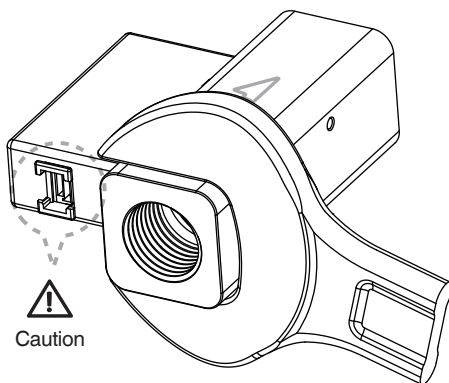
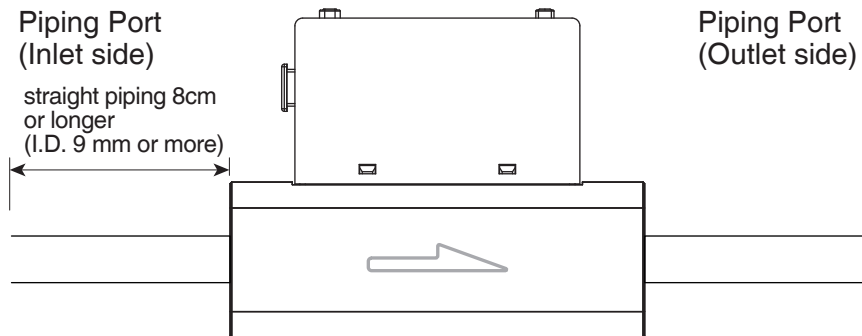

When piping with metallic area, please refer to the applicable torque below.

Over torquing may be damaged the product. When insufficient torque, the connection may loosen to cause air leakage.

After installation completed, please make gas and power on and operate properly and test leakage to verify the installation correct.

Piping Specification	Required Torque
Rc1/2, G1/2	28 ~ 30 N.m
Rc3/4, G3/4	

1.2 Mounting Bracket / Optional Parts

The LCD display may be difficult to see at certain angles.

The sensor can be installed horizontally or vertically, but the flow rates may change because of the installation way of the product or piping.

The tightening torque for screws should be under 0.3 ± 0.1 N.m.

Mounting screw
M3 x 0.5P x 5L

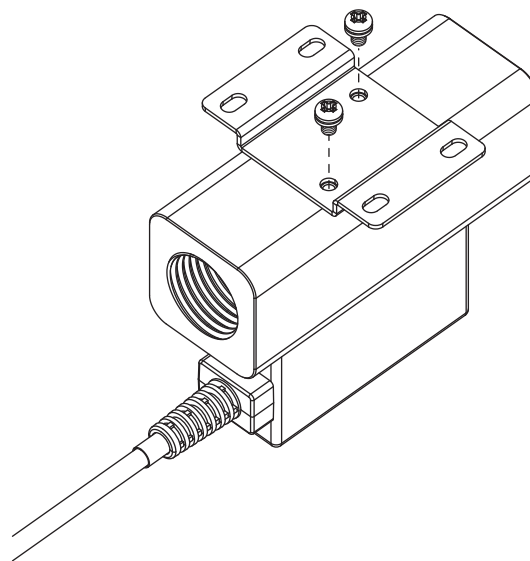

Mounting screw

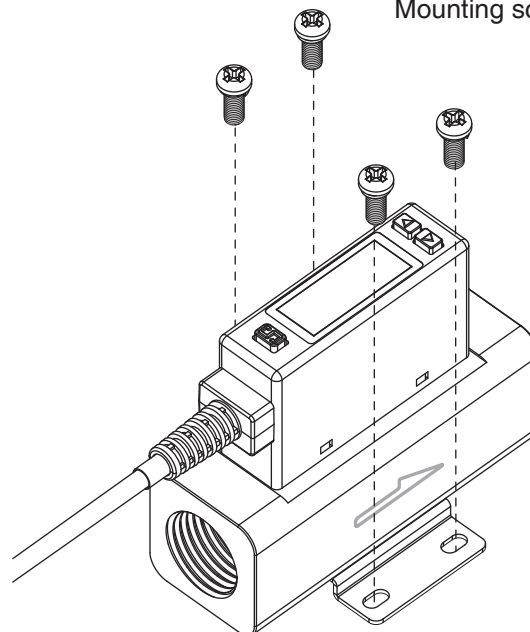

1.3 Wiring Diagrams

1.3.1 NPN Output, Analog Output and External Input

● NPN Output / Analog Voltage Output / External Input

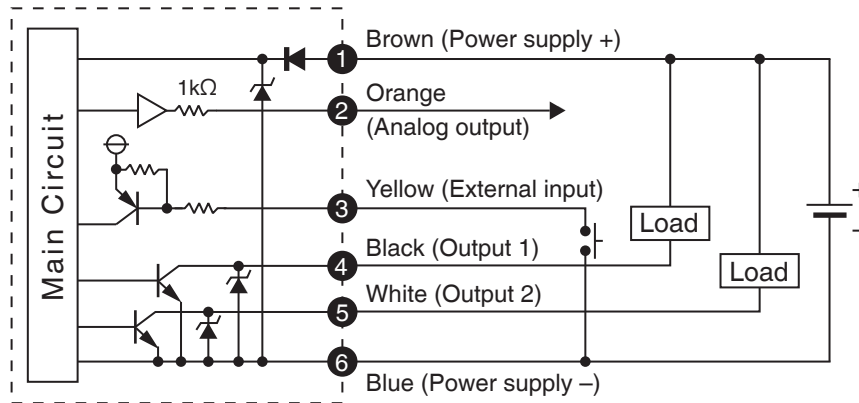

● NPN Output / Analog Current Output / External Input

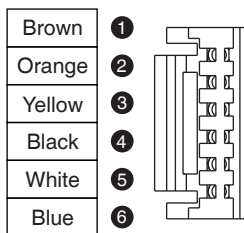
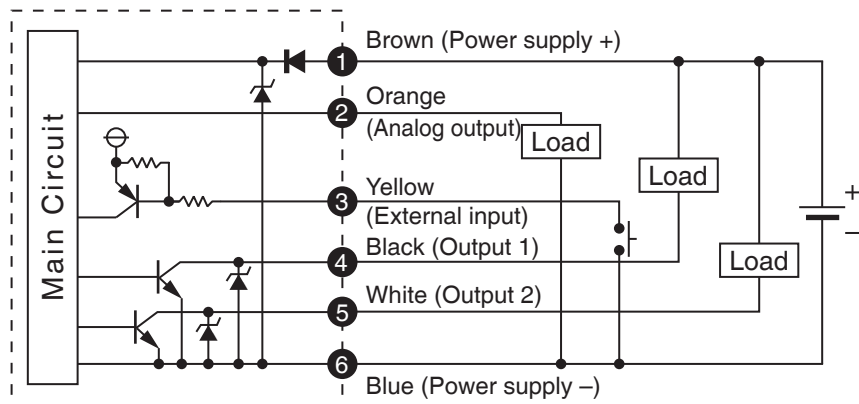

Pin No.	Line color	Content
1	Brown	Power supply (DC 12 to 24V DC)
2	Orange	Analog voltage output : 1 ~ 5V Analog current output : 4 ~ 20mA
3	Yellow	External input
4	Black	Output 1 (Max. load current : 125mA)
5	White	Output 2 (Max. load current : 125mA)
6	Blue	0V (GND)

1.3.2 PNP Output, Analog Output and External Input

● PNP Output / Analog Voltage Output / External Input

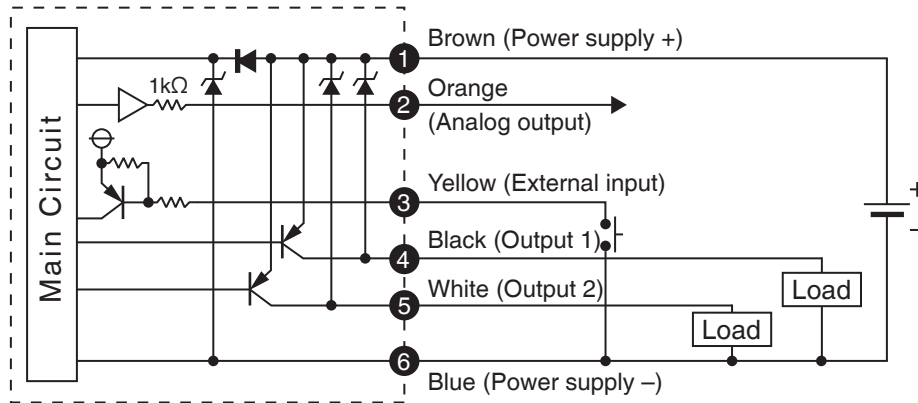

● PNP Output / Analog Current Output / External Input

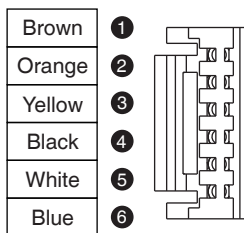
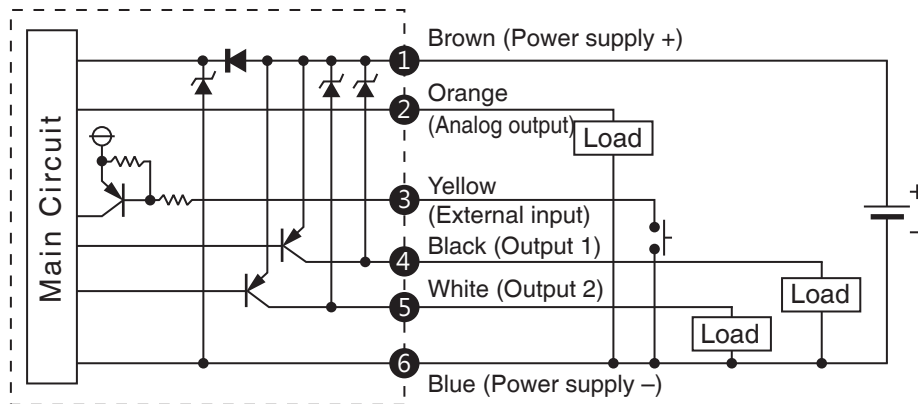

Pin No.	Line color	Content
1	Brown	Power supply (DC 12 to 24V DC)
2	Orange	Analog voltage output : 1 ~ 5V Analog current output : 4 ~ 20mA
3	Yellow	External input
4	Black	Output 1 (Max. load current : 125mA)
5	White	Output 2 (Max. load current : 125mA)
6	Blue	0V (GND)

1.3.3 NPN Output, RS-485 Modbus

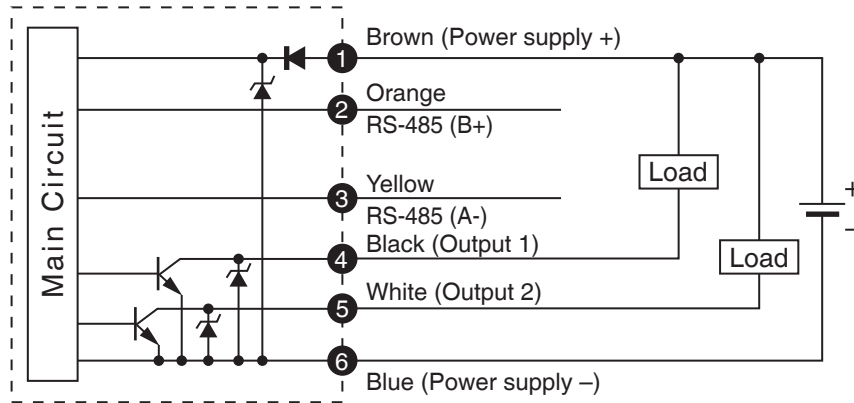

1.3.4 PNP Output, RS-485 Modbus

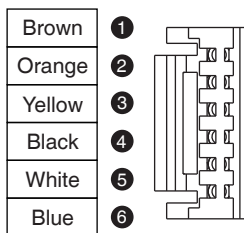
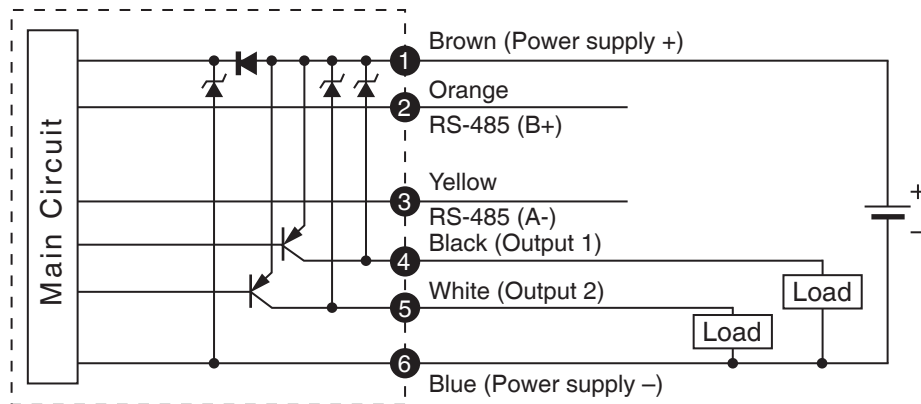

Pin No.	Line color	Content
1	Brown	Power supply (DC 12 to 24V DC)
2	Orange	RS-485 (B+)
3	Yellow	RS-485 (A-)
4	Black	Output 1 (Max. load current : 125mA)
5	White	Output 2 (Max. load current : 125mA)
6	Blue	0V (GND)

2 How to Use

2.1 Names and Functions of Individual Parts

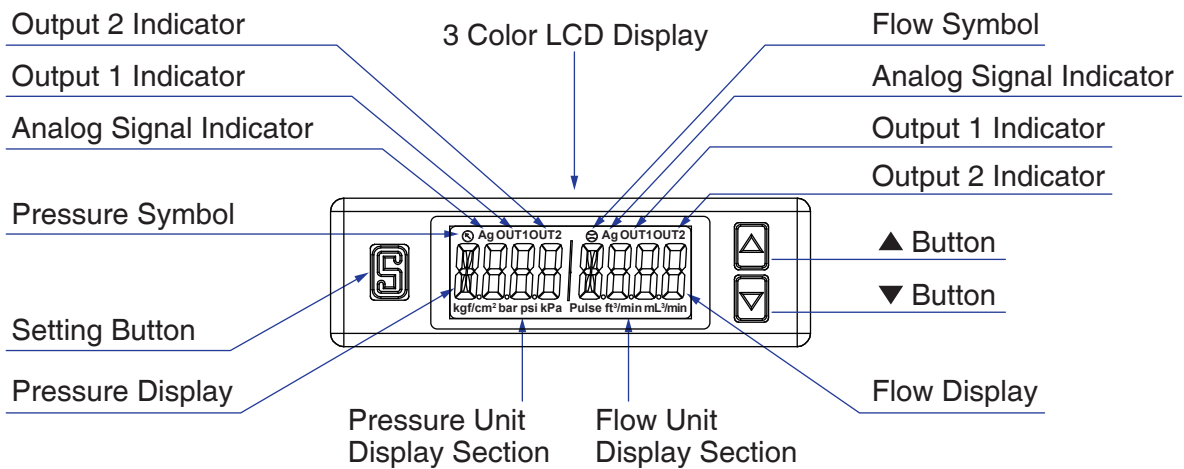
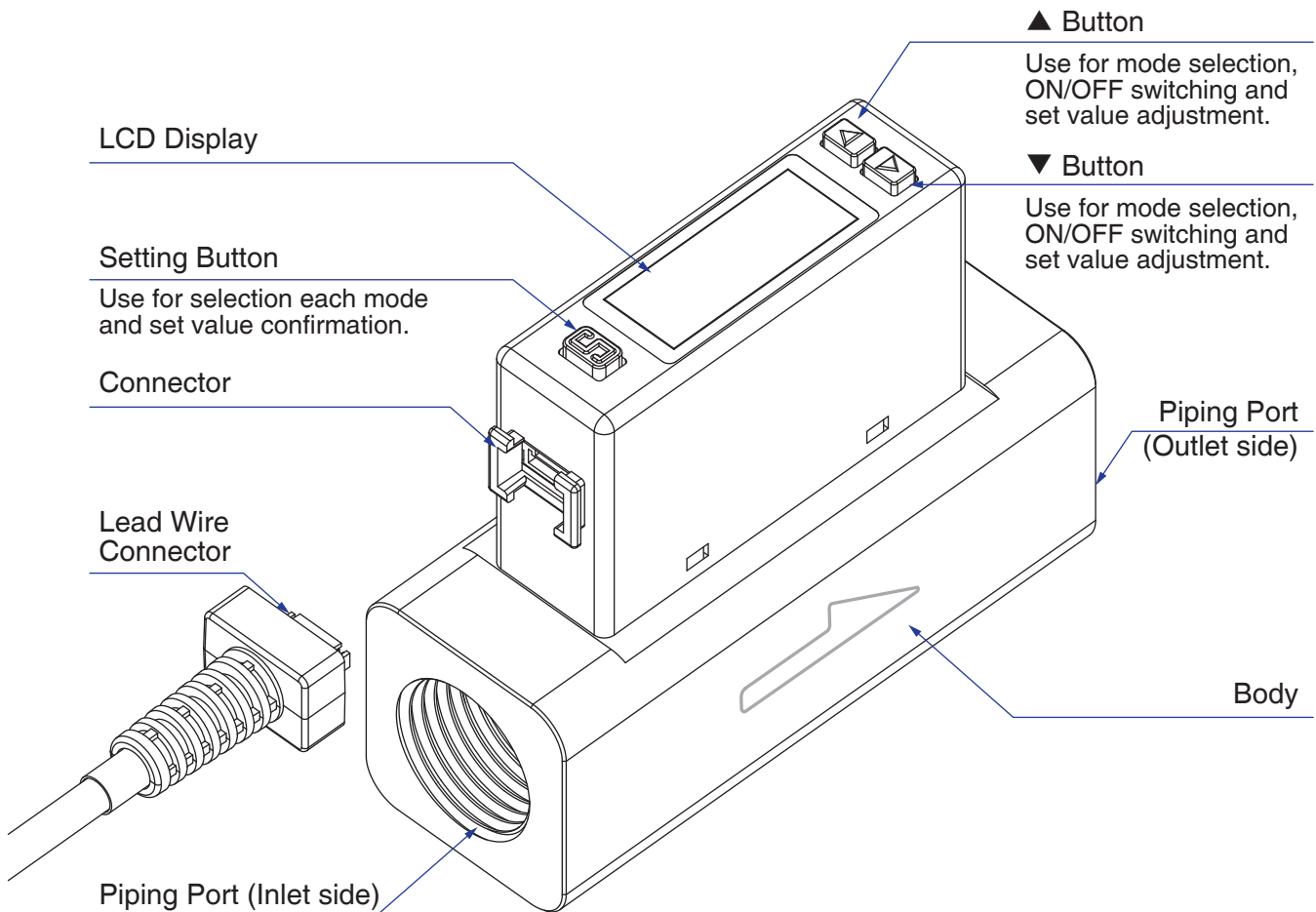

2.2 Function Instruction

● Function Setting Mode

Function Code	Item	Default setting	Explanation
[F-01]	[oUt 1] OUT1 setting	oUt 1	Select Output 1 corresponding to flow sensor or pressure sensor. Set the flow rate or pressure value to switch ON/OFF.
	[oUt 1] OUT1 sensor correspondence	FLoY	
	[FLoY] OUT1 output mode	HYS	
	[oUt 1] OUT1 output type	no	
	[FL- 1] OUT1 set value input	50% of maximum measured flow rate 501 : 250 L/min 102 : 500 L/min 202 : 1000 L/min	
	[FH- 1] OUT1 set value input	60% of maximum measured flow rate 501 : 300 L/min 102 : 600 L/min 202 : 1200 L/min	
[F-02]	[oUt 2] OUT2 setting	oUt 2	Select Output 2 corresponding to flow sensor or pressure sensor. Set the flow rate or pressure value to switch ON/OFF.
	[oUt 2] OUT2 sensor correspondence	FLoY	
	[FLoY] OUT2 output mode	HYS	
	[oUt 2] OUT2 output type	no	
	[FL- 2] OUT2 set value input	50% of maximum measured flow rate 501 : 250 L/min 102 : 500 L/min 202 : 1000 L/min	
	[FH- 2] OUT2 set value input	60% of maximum measured flow rate 501 : 300 L/min 102 : 600 L/min 202 : 1200 L/min	
[F-03]	[Lor] LCD Display setting	Lor	Select back light color and display mode.
	[d,SP] LCD Display corresponding to output	oUt 1	
	[LoL] LCD Display color selection	SoG	
[F-04]	[rESP] Response time selection	rESP	Select the response time for analog output. Pressure sensor: 2.5ms ~ 1500ms Flow sensor: 50ms ~ 1500ms
	[rESP] Flow/Pressure sensor selection	FLoY	
	[FLoY] Response time selection	800(ms)	
[F-05]	[UPdR] Display refresh time selection	UPdR	Display refresh cycle can be set in 200ms, 500ms or 1000ms.
	[UPdR] Flow/Pressure sensor selection	FLoY	
	[UPdR] Display refresh time of flow sensor selection	500(ms)	

Function Code	Item	Default setting	Explanation
[F - 06]	[Unit] Unit selection	Unit	Select the UNIT of pressure / flow sensor.
	[FLU] Flow unit selection	LPH	
	[PRES] Pressure unit selection	Unit	
[F - 07]	[rEFE] Flow reference standard selection	rEFE	Select the flow value is shown under standard (ANR) or normal condition (NOR).
	[rEFE] Flow reference standard selection	Rnr	
[F - 08]	[RnU] Analog output selection	RnU	Select the analog corresponding to pressure or flow sensor.
	[RnU] Analog output selection	FLU	
[F - 09]	[EEPr] Accumulated value hold selection	EEPr	To save the last accumulated flow value every 2 or 5 minutes.
	[EEPr] Accumulated value hold selection	oFF	
[F - 10]	[dIS] Flow sensor display mode selection	dIS	Select to display Instantaneous Flow or Accumulated Flow Mode.
	[dSP] Flow sensor display mode selection	ns	
[F - 91]	[EEo] Power-Save mode selection	EEo	Select if turn on power-save mode to reduce power consumption
	[EEo] Power-Save mode selection	no	
[F - 92]	[inP] External input selection	inP	Select for Accumulated flow rate zero clear, Auto-Shift or Auto-Shift zero.
	[inP] External input selection	r_r	
[F - 93]	[nbUS] Modbus RTU setting	nbUS	Set ID number, baud rate and transmission format.
	[id] ID number setting	1	
	[rRt] Baud rate setting	96 (9600 Bd)	
	[For] Transmission format setting	nB 1	
[F - 94]	[FinE] Fine adjustment Setting	FinE	The displayed value can be adjusted slightly.
	[FinE] Fine adjustment Setting	oFF	
[F - 95]	[FoutE] Forced output function	FoutE	To force output ON/OFF to test the switch function.
	[outE 1] Forced output function	oFF	
	[outE 2] Forced output function	oFF	
[F - 99]	[rESE] Reset to the default setting	rESE	Return to the factory default setting.
	[rSE] Reset to the default setting	oFF	

● Measurement Mode

Item	Explanation
Pressure display	Display pressure value.
Flow display	Display instantaneous flow rate.
Accumulated flow rate display	Display accumulated flow rate.
Pressure zero setting	The displayed pressure value can be adjusted to "0".
Instantaneous Flow rate zero setting	The displayed instantaneous flow rate value can be adjusted to "0".
Accumulated flow rate zero clear	The accumulated flow rate can be set to "0".
Peak value display	The maximum pressure or instantaneous flow can be detected when the power is supplied for a period.
Bottom value display	The minimum pressure or instantaneous flow can be detected when the power is supplied for a period.
Key lock/unlock mode	To prevent errors occurring due to unintentional changes of the set values.

2.3 Operation Instructions

Function Selection Mode

At Measurement Mode, press  button for more than 3 sec. to display [F-01]. Press  or  button to select other setting functions.

Press  for 3 sec. at Function Setting Mode to return to Measurement Mode.

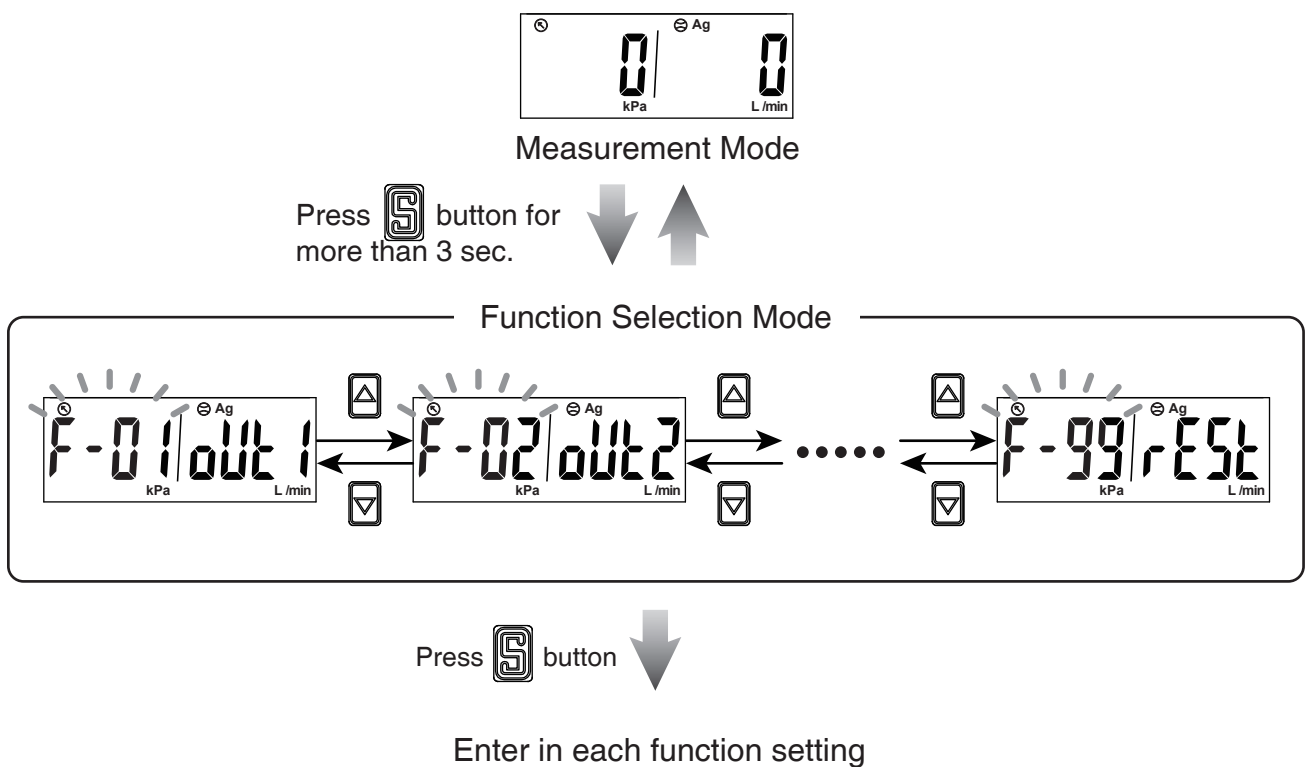

2.3.1 [F-□] OUT1 Setting Selection

Setting corresponding sensor and operating mode of OUT1.

● 1. Flow sensor setting

Press or button at Function Setting Mode to display [F-□] [OUT □].

Press button

Sensor Selection

Press or button to select flow sensor of OUT1.

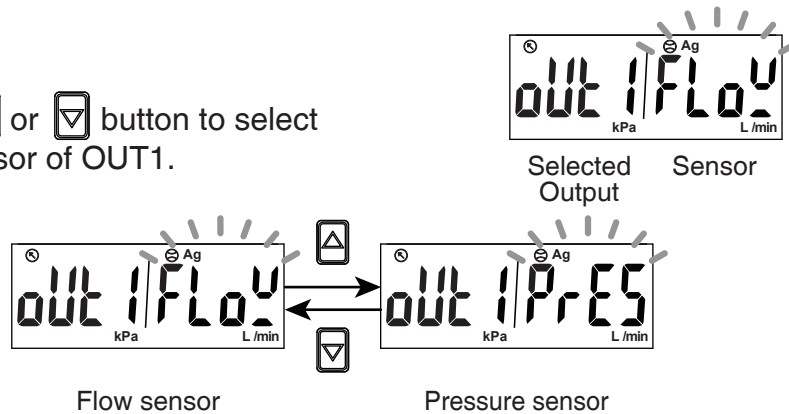

Press button

Output Mode Setting

Select output mode :

Press or button to select output mode of OUT1.

4 output modes included.

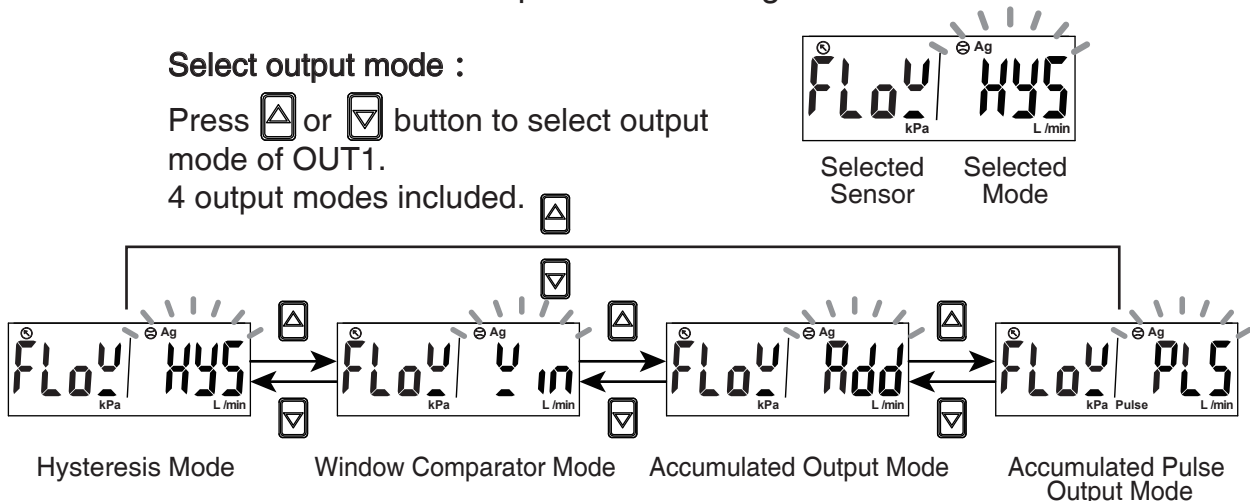



※NOTE : The Accumulated Pulse Output Mode can only be set in OUT1, and OUT2 does not have this setting.

Press button (to be continued)

Output Type Setting

OUT1 type setting :

Press  or  button to select OUT1 type.

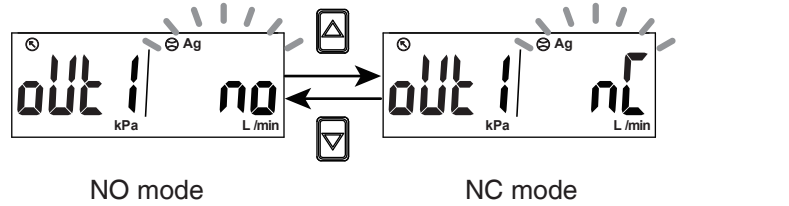

※NOTE : Type setting will not display when Accumulated Pulse Output Mode is set.

Press  button

Set Value Setting

Out1 set value setting :

Press  or  button to adjust the set value.

Hysteresis Mode [HYS] : [FL - I] · [FH - I]

Window Comparator Mode [W C] : [FL - I] · [FH - I]

Accumulated Output Mode [ADD] : [ADL I] · [ADH I]

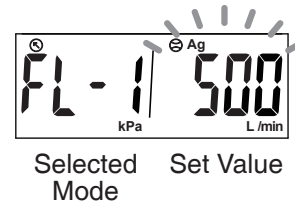



※NOTE : Set value setting will not display when Accumulated Pulse Output is set.

Press  button

Fixed Hysteresis Setting

Fixed hysteresis setting :

Press  or  button to adjust fixed hysteresis value.

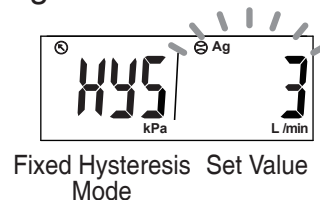

※NOTE : Fixed hysteresis setting will not display when Hysteresis Mode, Accumulated Output Mode and Accumulated Pulse Output Mode is set.

Press  button to return to Function Selection Mode



● 2. Pressure sensor setting

Press or button at Function Selection Mode to display [F-01] [OUT1].

Press button

Sensor Selection

Press or button to select pressure sensor of OUT1.

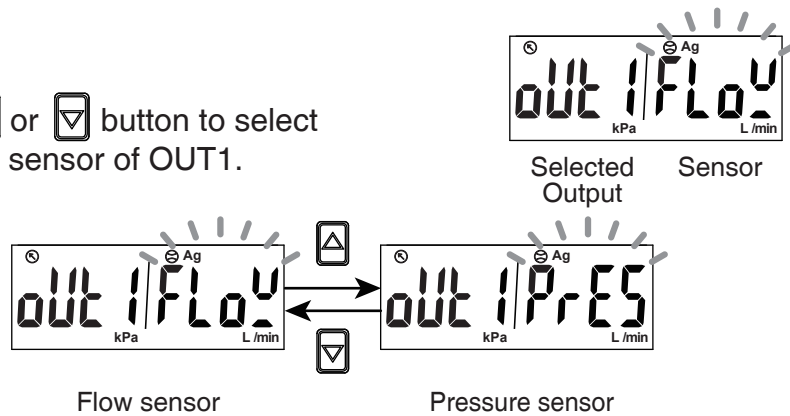

Press button

Output Mode Setting

Select output mode :

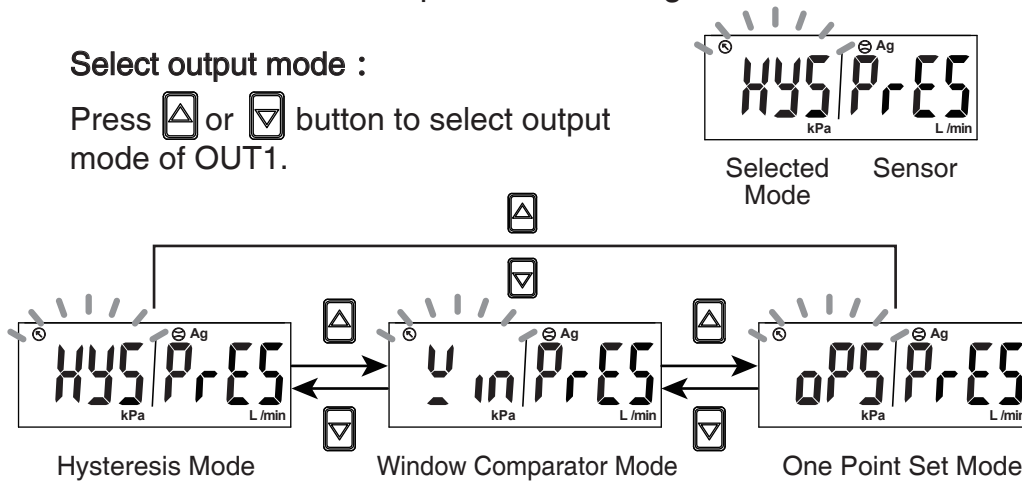

Press or button to select output mode of OUT1.



Press button (to be continued)

Output Type Setting

OUT1 type setting :

Press  or  button to select OUT1 type.

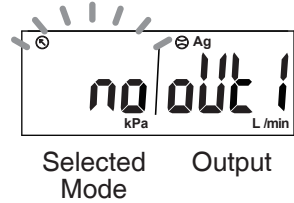
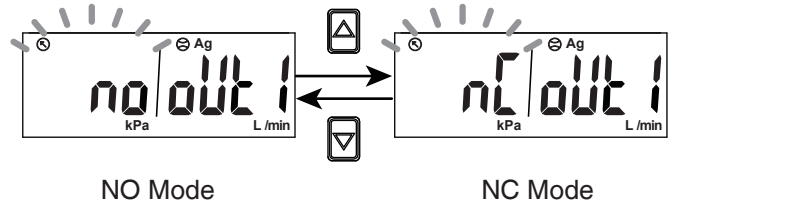

Press  button

Set Value Setting

Out1 set value setting :

Press  or  button to adjust the set value.

Hysteresis Mode [HYS] : [L - I] · [H - I]

Window Comparator Mode [W C] : [L - I] · [H - I]

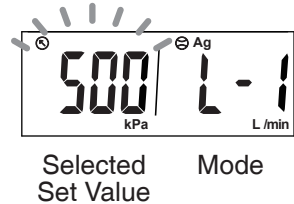

One Point Set Mode [OPS] : [P - I]



Press  button

Fixed Hysteresis Setting

Fixed hysteresis setting :

Press  or  button to adjust fixed hysteresis value.

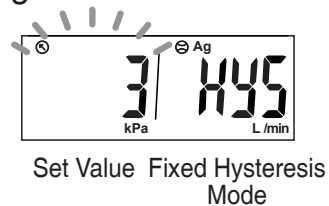

NOTE : Fixed hysteresis setting will not display when Hysteresis Mode is set.

Press  button to return to Function Selection Mode



Normal Open Mode

Hysteresis Mode

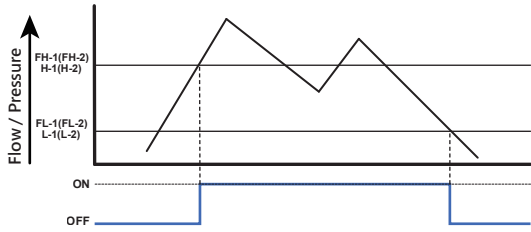

Normal Close Mode

Hysteresis Mode

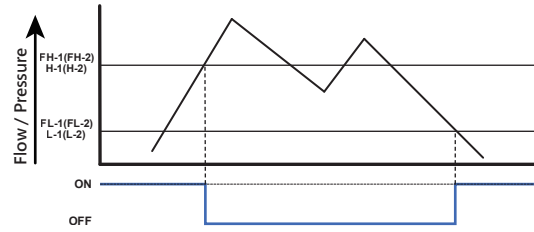

Window Comparator Mode

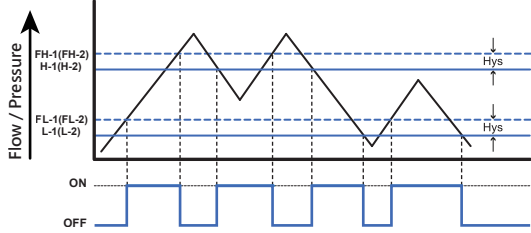

Window Comparator Mode

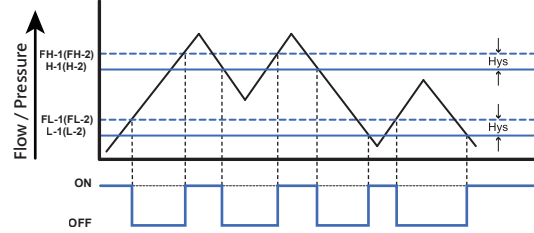

One Point Set Mode

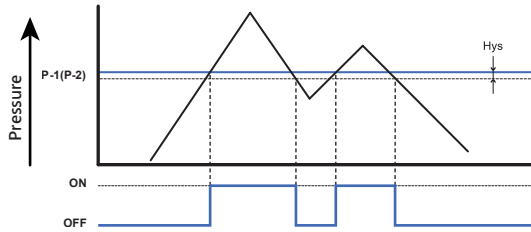

One Point Set Mode

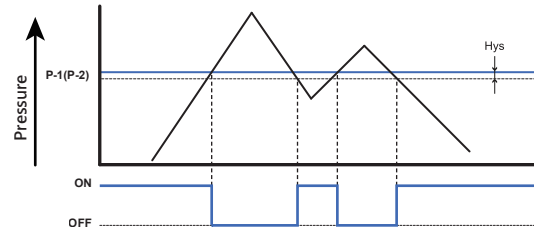

Accumulated Output Mode

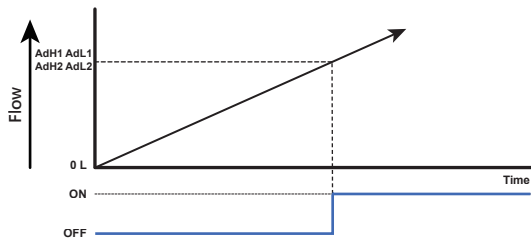

Accumulated Output Mode

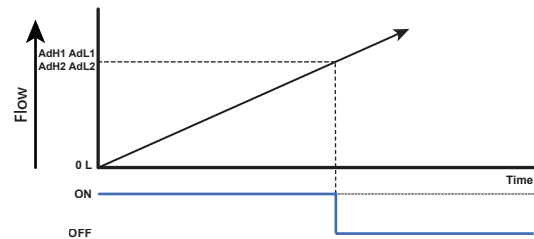

Accumulated Pulse Output Mode

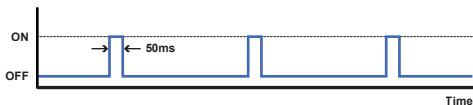



Flow Range	500L	1000L	2000L
Pulse Output Rate	5L	10L	10L

[NOTE:]

- *1. In case hysteresis is set at less than or equal to 2 digits, switch output may chatter if input pressure fluctuates near the set point.
- *2. When using window comparator mode, the difference between two set points must be greater than the fixed hysteresis, otherwise will cause the switch output to malfunction.

2.3.2 [F-02] OUT2 Setting Selection

Setting corresponding sensor and operating mode of OUT2.

1. Press  or  button at function setting mode to start "OUT 2 Setting" [F-02] [OUT2].
2. Check the [F-01] for the same follow setting.

NOTE : The OUT2 Setting dose not have Accumulated Pulse Output Mode.

2.3.3 [F-03] LCD Display Color Selection

4 LCD Display Color Modes of output value selection.

< Operation >

Press  or  button at Function Selection Mode to display [F-03] [CLor].

Press  button

Output Selection

Press the  or  button to select color display for OUT1 or OUT2.

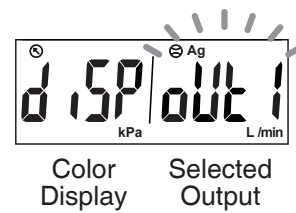
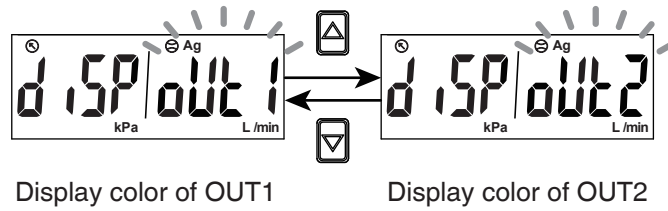

Press  button

Display Color Mode Selection

Press the  or  button to select Display Color Mode.

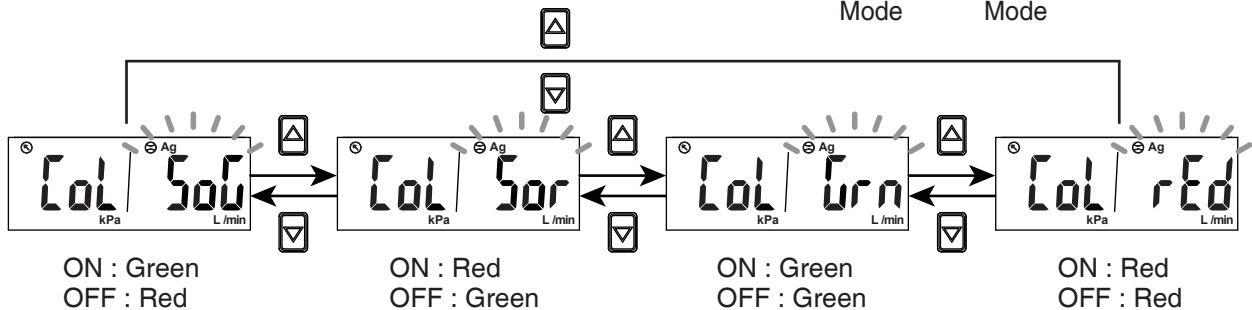

Press  button to return to Function Selection Mode



2.3.4 [F-04] Response Time Selection

Select proper response time to avoid switch output chattering.

● 1. Flow sensor setting

Press or button at Function Selection Mode to display [F-04] [rESP].

Press button

Sensor Selection

Press or button to select the flow sensor.

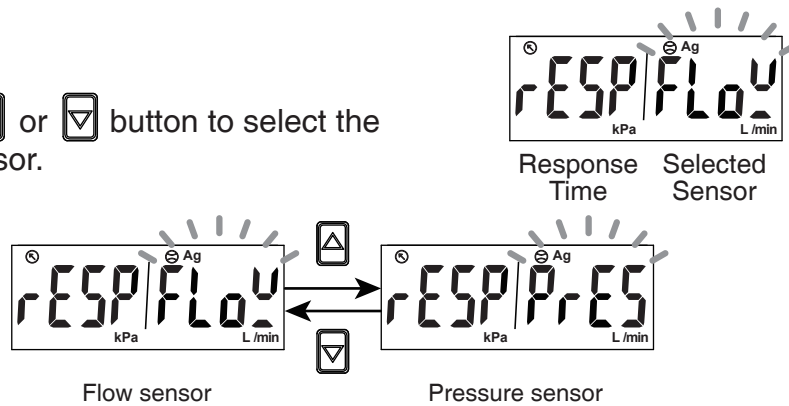

Press button

Response Time Selection

Setting response time of flow sensor :

Press or button to select response time.

7 Response time selections include:
50ms, 80ms, 120ms, 200ms, 400ms, 800ms, 1500ms

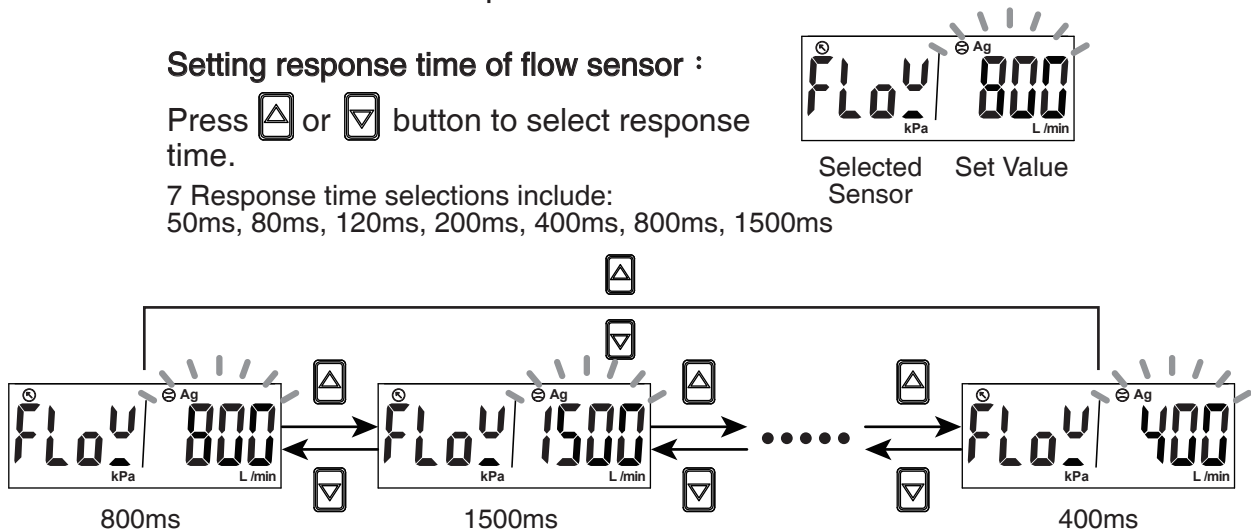

Press button to return to Function Selection Mode



● 2. Pressure sensor setting

Press or button at Function Selection Mode to display [F-04] [rESP].

Press button

Sensor Selection

Press or button to select the pressure sensor.

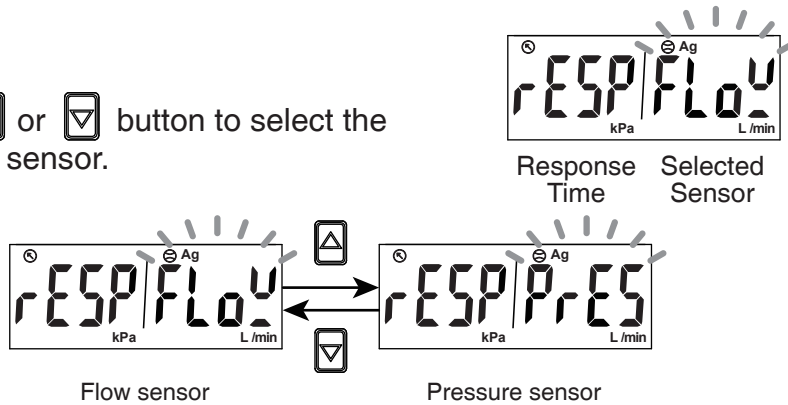

Press button

Response Time Selection

Setting response time of pressure sensor :

Press or button to select response time.

7 Response time selections include:
2.5ms, 25ms, 100ms, 250ms, 500ms, 1000ms, 1500ms

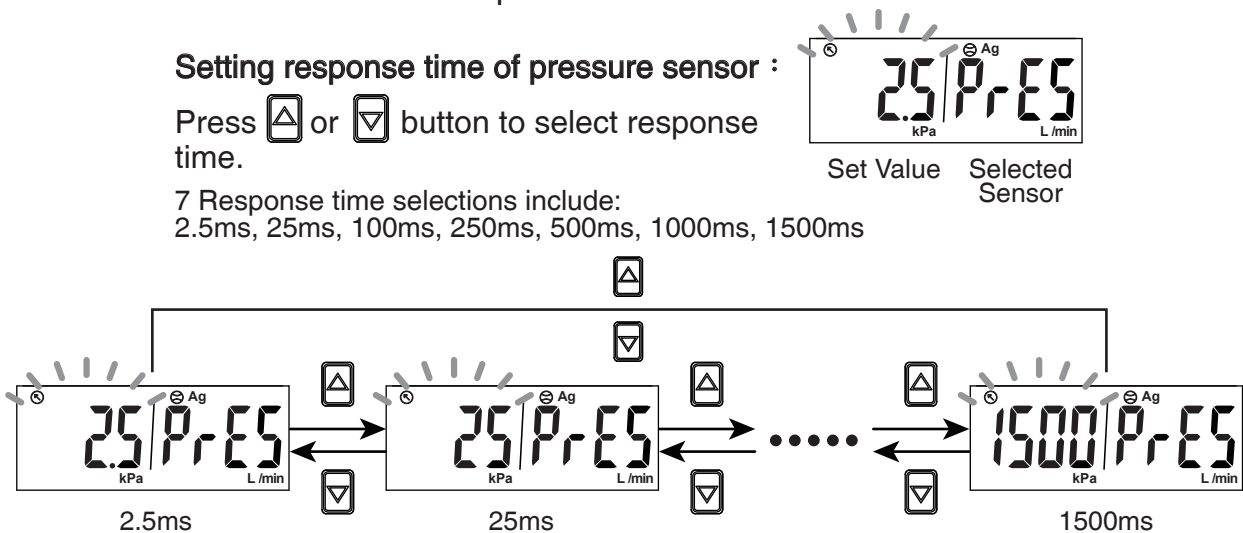

Press button to return to Function Selection Mode



2.3.5 [F-05] Display Refresh Time Selection

Select the proper display refresh time to reduce frequently changing value.

● 1. Flow sensor setting

Press  or  button at Function Selection Mode to display [F-05] [UPdR].

Press  button

Sensor Selection

Press  or  button to select the flow sensor.



Refresh Time Selected Sensor

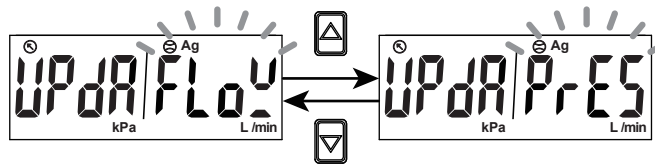

Flow sensor

Pressure sensor

Press  button

Display Refresh Time Setting

Setting refresh time of flow sensor :

Press  or  button to select refresh time.

3 display refresh time selections include:
200ms, 500ms, 1000ms

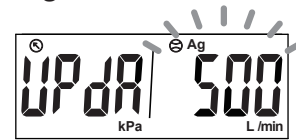

Refresh Time Set Value

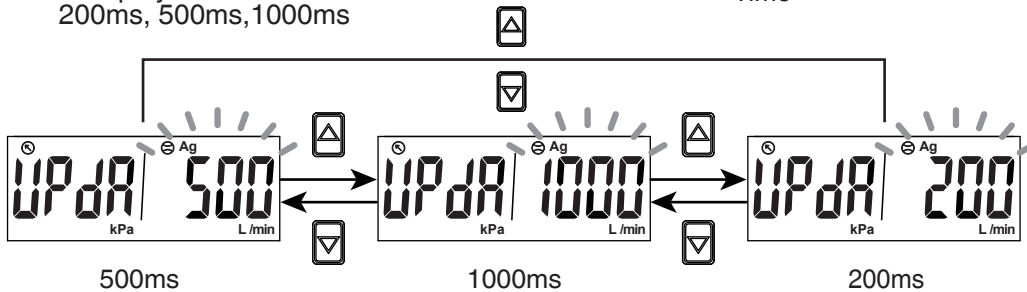

500ms

1000ms

200ms

Press  button to return to Function Selection Mode



● 2. Setting display refresh time of pressure sensor

Press or button at Function Selection Mode to display [F-05] [UPdR].

Press button

Sensor Selection

Press or button to select the pressure sensor.

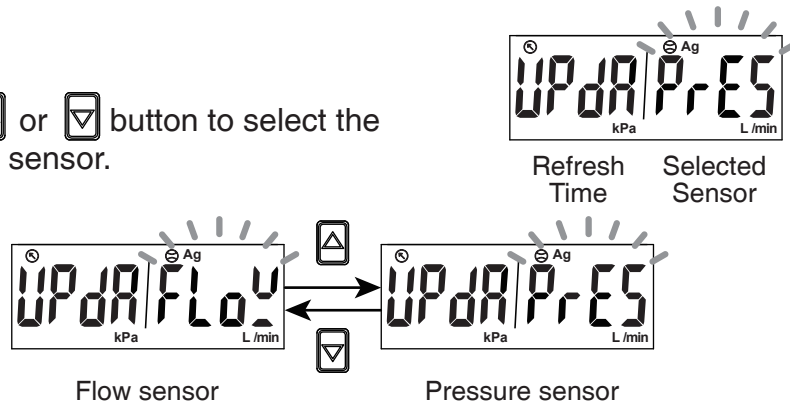

Press button

Display Refresh Time Setting

Setting refresh time of pressure sensor :

Press or button to select refresh time.

3 display refresh time selections include:
200ms, 500ms, 1000ms

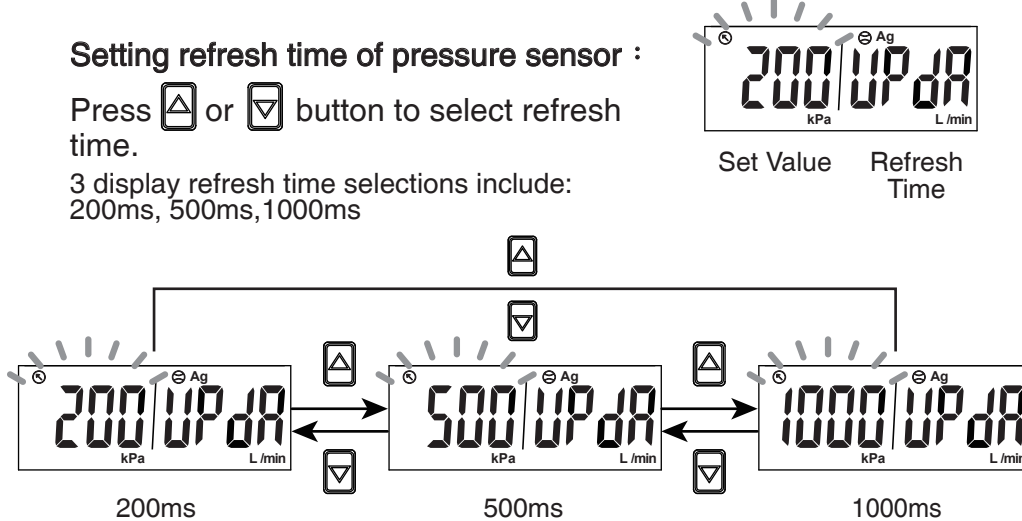

Press button to return to Function Selection Mode



2.3.6 [F-06] Unit Selection

Select the flow unit and pressure unit of the sensor.

< Operation >

Press  or  button at Function Selection Mode to display [F-06] [Unit] °

Press  button

Flow Unit Selection

Press  or  button to select flow unit.

2 flow unit selections include:
LPM(L/min), CFM(ft³/min*10⁻²)

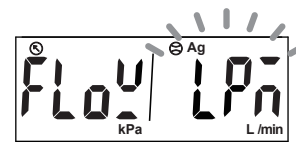

Flow Sensor Set Unit

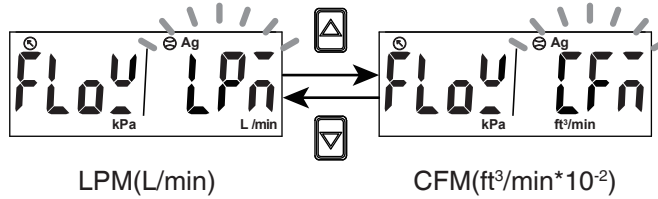



LPM(L/min)

CFM(ft³/min*10⁻²)

Press  button

Pressure Unit Selection

Press  or  button to select pressure unit.

4 pressure unit selections include:
kPa, kgf/cm², bar, psi

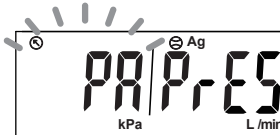

Set Unit Pressure Sensor

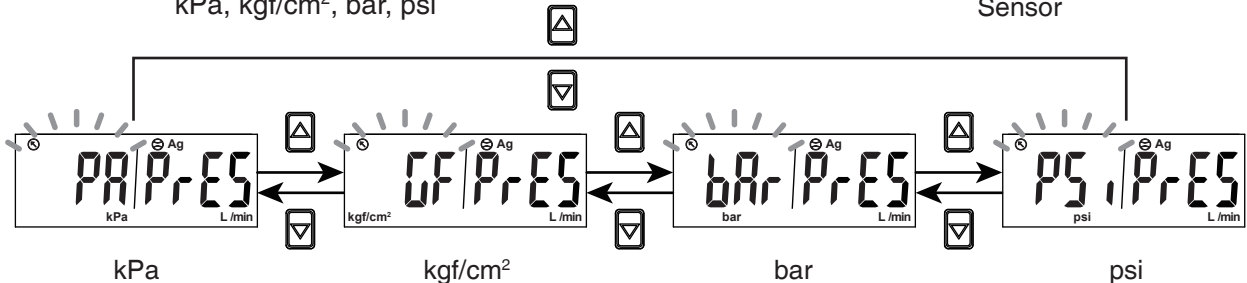

kPa

kgf/cm²

bar

psi

Press  button to return to Function Selection Mode



2.3.7 [F-07] Flow Reference Standard Selection

Select the flow value is shown under standard or normal condition.

< Operation >

Press  or  button at Function Selection Mode to display [F-07] [rEFE] °

Press  button 

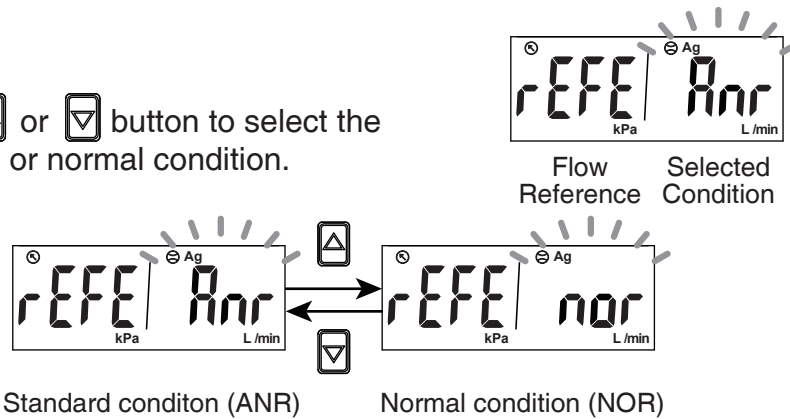

Flow Reference Standard Selection

Press  or  button to select the standard or normal condition.



※NOTE :

1. Standard condition (ANR): the display value is calculated under 20°C, 1atm.
2. Normal condition (NOR): the display value is calculated under 0°C, 1atm.
3. Flow rate in the specification is the value at standard condition (ANR).

Press  button to return to Function Selection Mode 



2.3.8 [F-08] Analog Output Selection

Select the analog output signal is for flow sensor or pressure sensor.

< Operation >

Press  or  button at Function Selection Mode to display [F-08] [AnG] °

Press  button

Sensor Selection

Press  or  button to select the sensor of analog output.

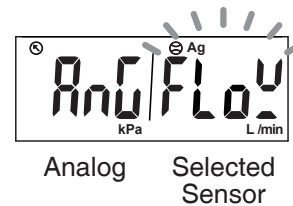
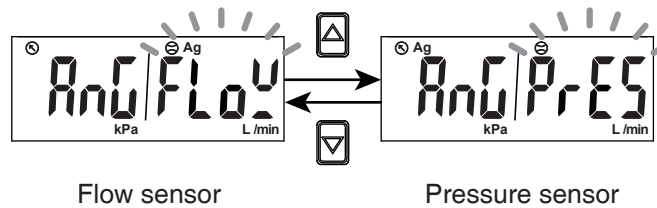

※NOTE : This function is not available with Output Specification -02 and -04.

Press  button to return to Function Selection Mode

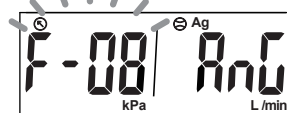

2.3.9 [F-09] Accumulated Value Hold Selection

The default setting is "OFF", the accumulated flow value is zeroed when the power supply is turned off.

Select this function to keep accumulated flow value to be stored in permanent memory and reload the recent saved accumulated value after power supply turns on.

< Operation >

Press  or  button at Function Selection Mode to display [F-09] [EEP_r] °

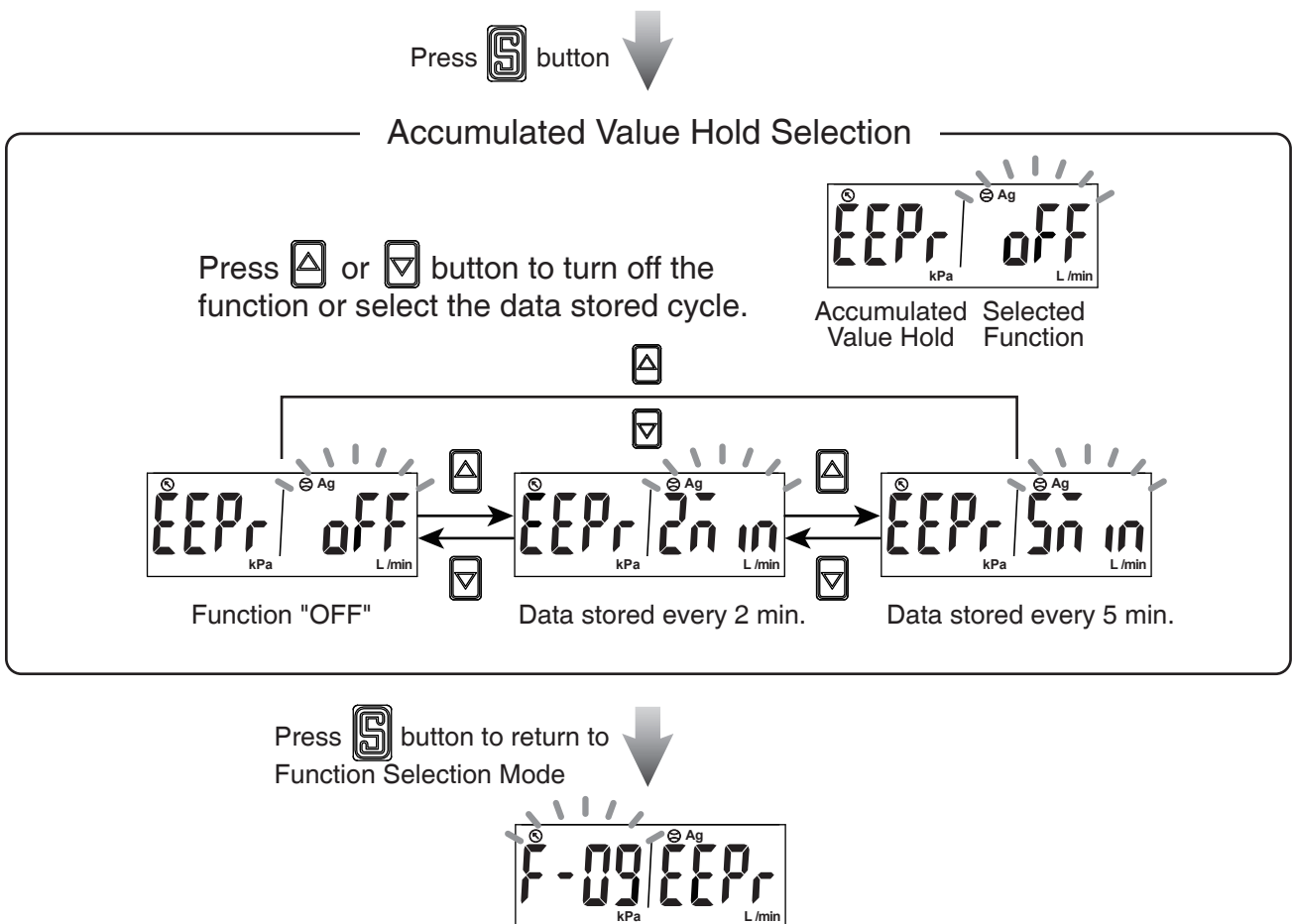

※ NOTE :

The maximum writable limit of the memory device is 1 million cycles. If the sensor is operated 24 hours per day, the durability is calculated as below:

- ◆ 5 minutes x 1 million cycles = 5 million minutes = 9.5 years
- ◆ 2 minutes x 1 million cycles = 2 million minutes = 3.8 years

2.3.10 [F- 10] Flow Sensor Display Mode Selection



Select to display Instantaneous Flow or Accumulated Flow Mode.

< Operation >



Press  or  button at Function Selection Mode to display [F- 10] [d .5] °

Press  button 

Display Mode Selection

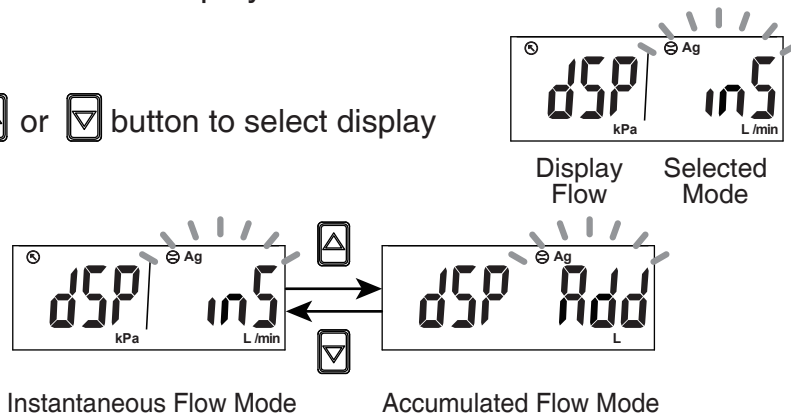
Press  or  button to select display mode.



Press  button to return to Function Selection Mode 

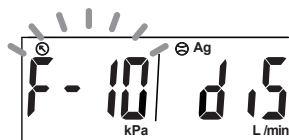

2.3.11 [F-9 I] Power-Save Mode Selection

Select Power-Save Mode at Measurement Mode.

During the Power-Save Mode, the main display will turned off if no buttons is pressed in 30 sec., press any keys to leave the Power-Save Mode.

< Operation >

Press  or  button at Function Selection Mode to display [F-9 I] [ECo] °

Press  button

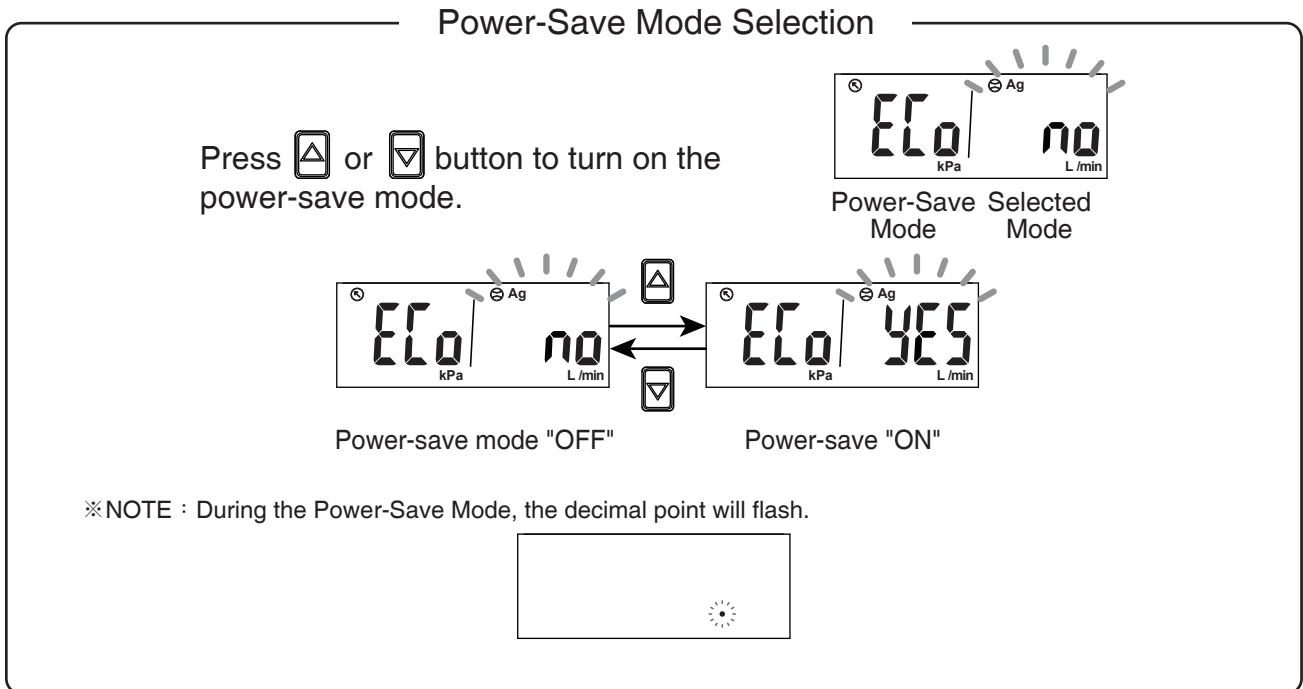

Press  button to return to Function Selection Mode



2.3.12 [F-92] External Input Selection

Accumulated flow external reset : The accumulated flow value will reset to "0" when an external input signal is applied.

Auto-shift : The instantaneous flow rate will regard as the standard when the external input signal is applied. The switch output function operates relative to its change.

Auto-shift zero : The instantaneous flow rate is reset to zero to regard as standard when the external input signal is applied. The switch output function operates relative to its change.

This function is only for output 1 corresponding to flow sensor action point. When external signal is input, please connect the input wire to GND for 30 ms or more.

< Operation >

Press  or  button at Function Selection Mode to display [F-92] [kPa] °.

Press  button

External Input Selection

Press  or  button to select external input function.

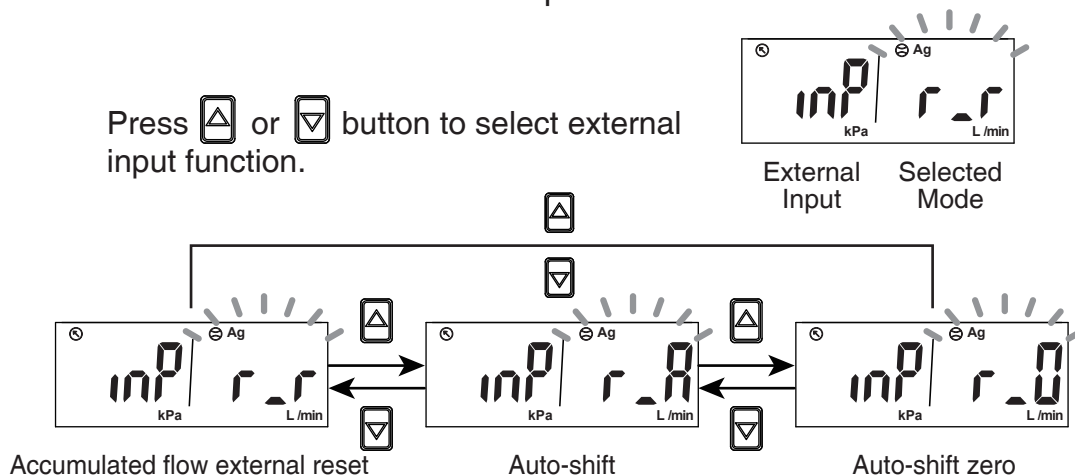

※NOTE :

1. This function is not available with Output Specification -02 and -04.
2. When external signal is input, the instantaneous flow rate value will be shown "0000".



Press  button to return to Function Selection Mode

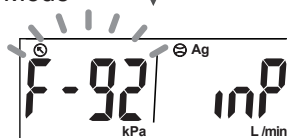

2.3.13 [F-93] Modbus RTU Setting

MODBUS transmission protocol can be set according to user requirements.

Press or button at Function Selection Mode to display [F-93] [MODBUS] .

Press button

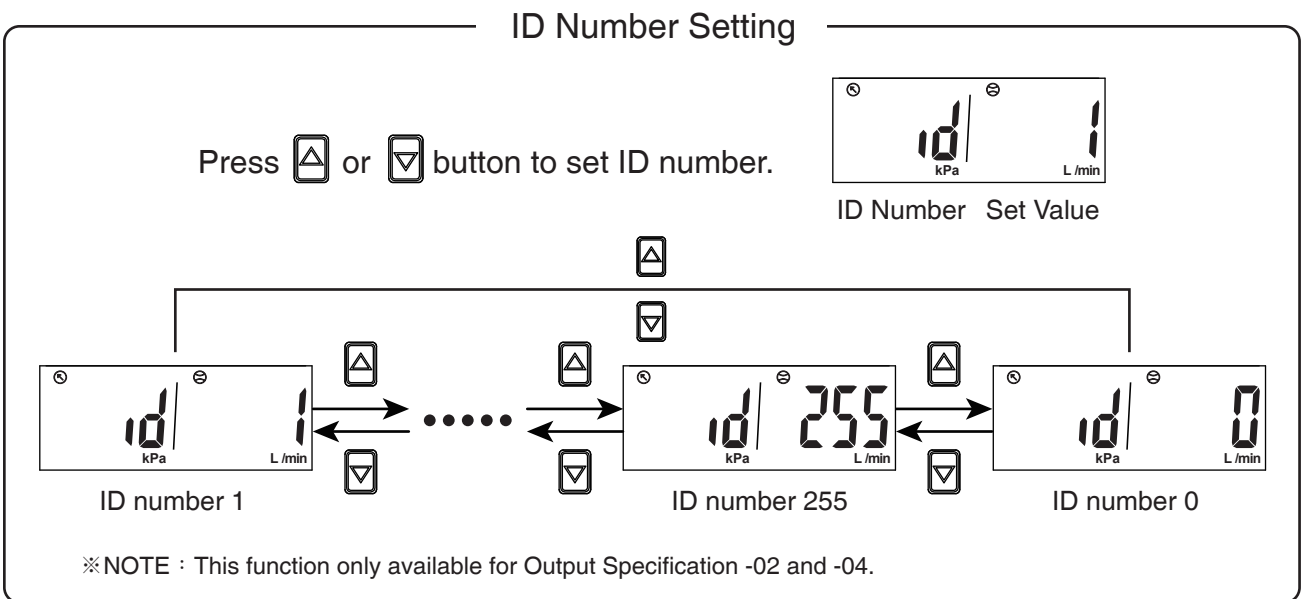

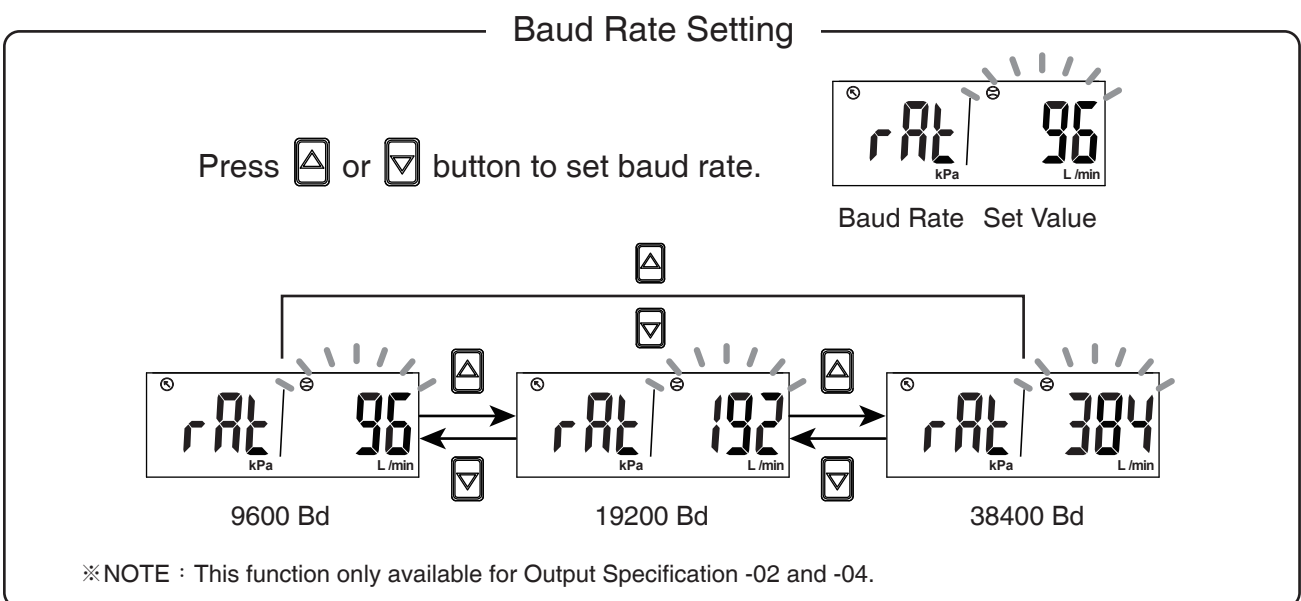

Press button



Press button (to be continued)

Transmission Format Setting

Press  or  button to set transmission format.

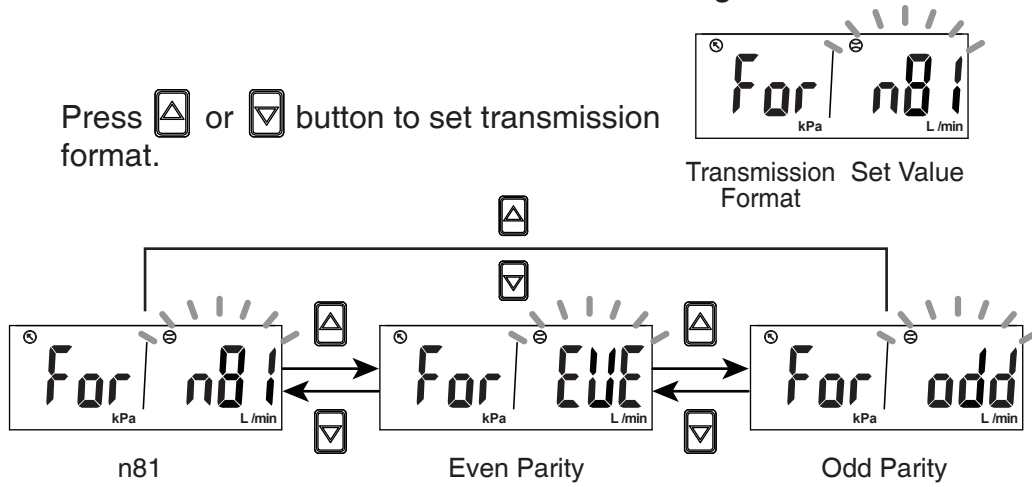

Press  button

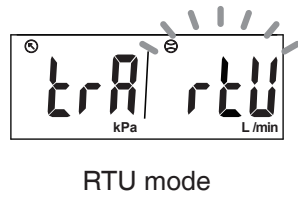

Press  button to return to Function Selection Mode



2.3.14 [F-94] Fine Adjustment Setting

This function is to fine adjust flow and pressure display values. Display values can be calibrated to within $\pm 2.5\%$ R.D.

● 1. Fine adjustment of instantaneous flow value

Press or button at Function Selection Mode to display [F-94] [F inE] °

Press button ↓

Fine Adjustment Setting

Press or button to select fine adjustment OFF or to set fine adjustment instantaneous flow rate value or pressure value.

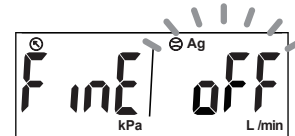

Fine Adjustment Set Value

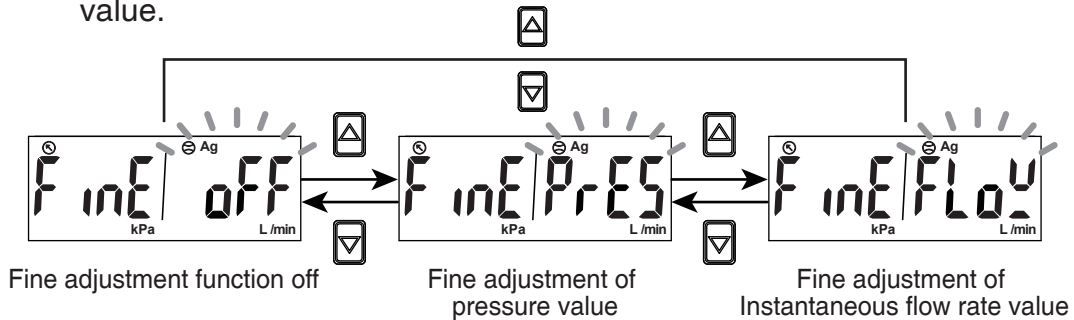

Fine Adjustment of Instantaneous Flow Rate Value

Fine adjustment of instantaneous flow rate value :

Press or button to set fine adjustment value.

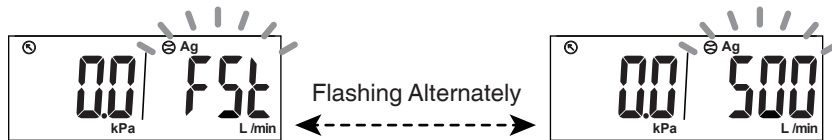

Set Value Fine adjustment setting

Set Value Instantaneous flow value

※NOTE : Display will flashing between instantaneous flow value and "FST".

Press button ↓

Return to the measurement mode

● 2. Fine adjustment of pressure value

Press or button at Function Selection Mode to display [F-94] [F inE] °

Press button ↓

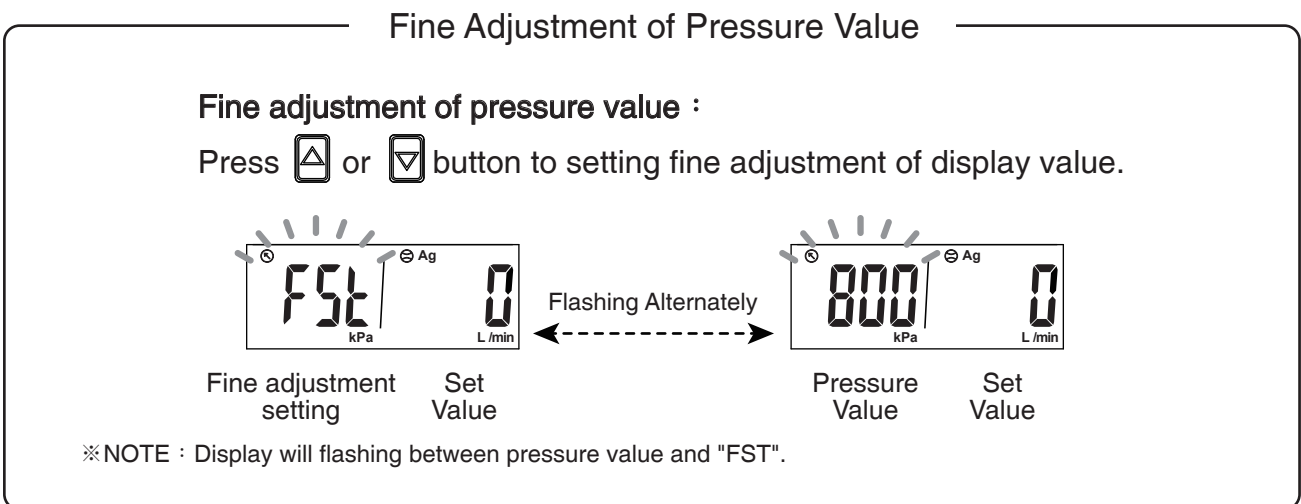
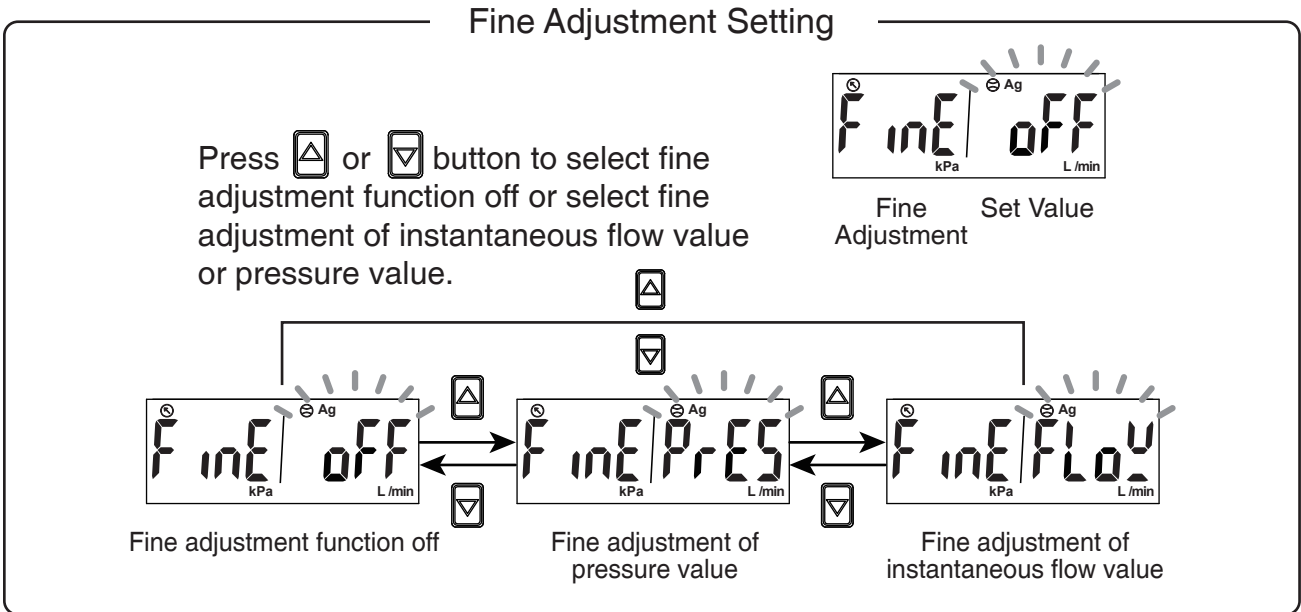

Press button ↓

Return to the measurement mode

2.3.15 [F-95] Forced Output Function

To force output ON/OFF to test the switch function.

< Operation >

Press  or  button at Function Selection Mode to display [F-95] [F_{OUT}].

Press  button

OUT1 setting

Press  or  button to setting OUT1.



Output 1 Set Value

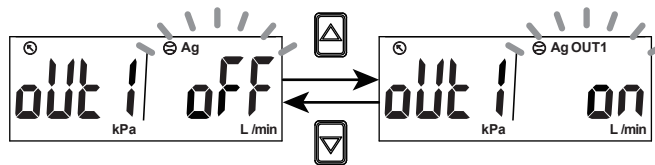

OUT1 OFF

OUT1 ON

Press  button

OUT2 setting

Press  or  button to setting OUT2.

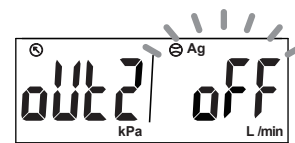

Output 2 Set Value

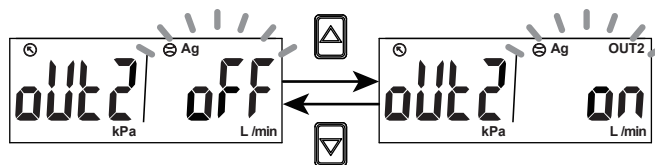

OUT2 OFF

OUT2 ON

Press  button to return to Function Selection Mode



2.3.16 [F-99] Reset to the Default Setting

The factory default settings can be restored.

< Operation >



Press  or  button at Function Selection Mode to display [F-99] [rESE] ◦

Press  button 

Reset to The Default Setting

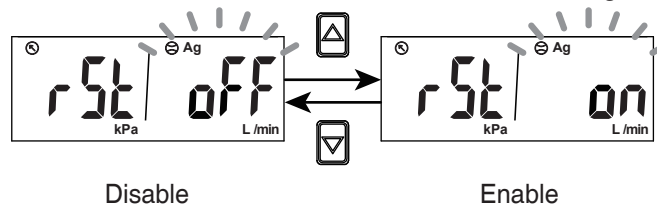
Press  or  button to return to the factory default setting.



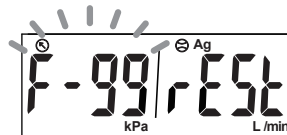

Press  button to return to Function Selection Mode 



2.3.17 Pressure Zero Adjustment Function

The displayed value can be adjusted to "0" when the pressure is within $\pm 3\%$ F.S. of the zero point at the time of shipment from the factory.

< Operation >

Press  and  button simultaneously over 3 sec. at the measurement mode (not Accumulated flow value display mode) until display [00]. And release holding the button to return measurement mode.

Measurement mode

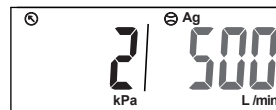

Press  and  button simultaneously over 3 sec.

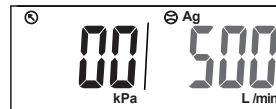

To release holding the button to return measurement mode.

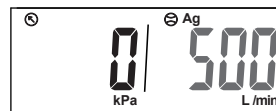



Pressure value return zero.

2.3.18 Instantaneous Flow Zero Adjustment Function

The displayed value can be adjusted to "0" when the measured flow is within $\pm 5\%$ F.S. of the zero point at the time of shipment from the factory.

< Operation >

Press  and  button simultaneously over 3 sec. at the measurement mode (not Accumulated flow value display mode) until display [00]. And release holding the button to return measurement mode.

Measurement mode

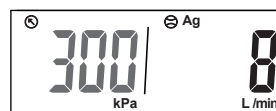

Press  and  button simultaneously over 3 sec.

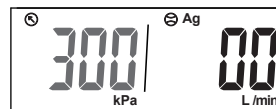

To release holding the button to return measurement mode.

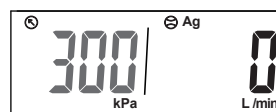



Instantaneous flow value return zero.

2.3.19 Reset Accumulated Flow Function

Accumulate flow value return to zero.

< Operation >

Press  and  button simultaneously over 3 sec. at the measurement mode (Accumulated flow value mode) until display zero.

And release holding the button to return measurement mode.

Measurement mode



Press  and  button simultaneously over 3 sec.

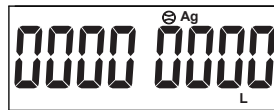

Accumulated value display zero.
To release holding the button to return measurement mode.

2.3.20 Peak Value Display

The maximum pressure and instantaneous flow, from when the power was supplied to this moment, is detected and updated.

< Operation >

Press  button over 3 sec. at the measurement mode. The maximum value will be displayed flashing, and is held.

Press  button return to the measurement mode.

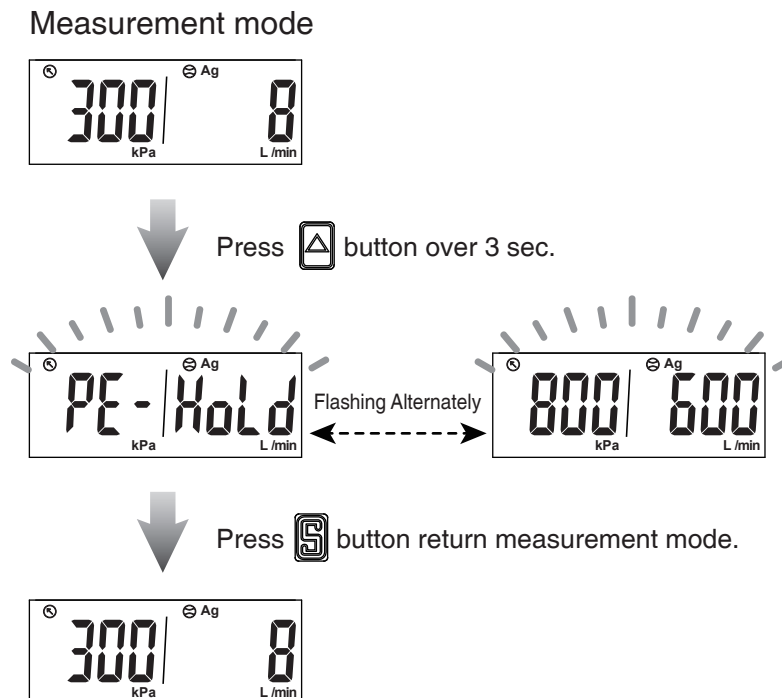

2.3.21 Bottom Value Display

The minimum pressure and instantaneous flow, from when the power was supplied to this moment, is detected and updated.

< Operation >

Press  button over 3 sec. at the measurement mode. The minimum value will be displayed flashing, and is held.

Press  button return to the measurement mode.

Measurement mode

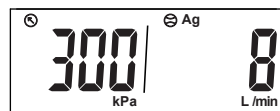

Press  button over 3 sec.

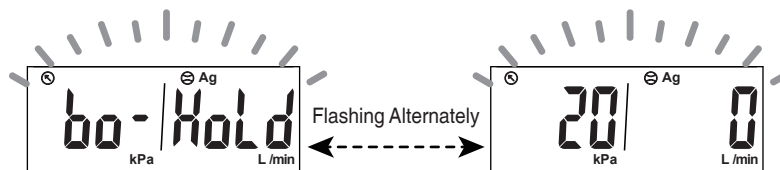

Press  button return measurement mode.

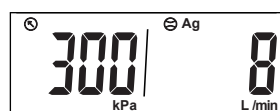

2.3.22 Key Lock / Unlock Mode

To prevent errors occurring due to unintentional changes of the set values. If a button operation is performed while the key lock setting is ON, [LoC] [on] is displayed for 1 sec.

< Operation >

Press  button over 5 sec. at measurement mode to select key lock/unlock setting.

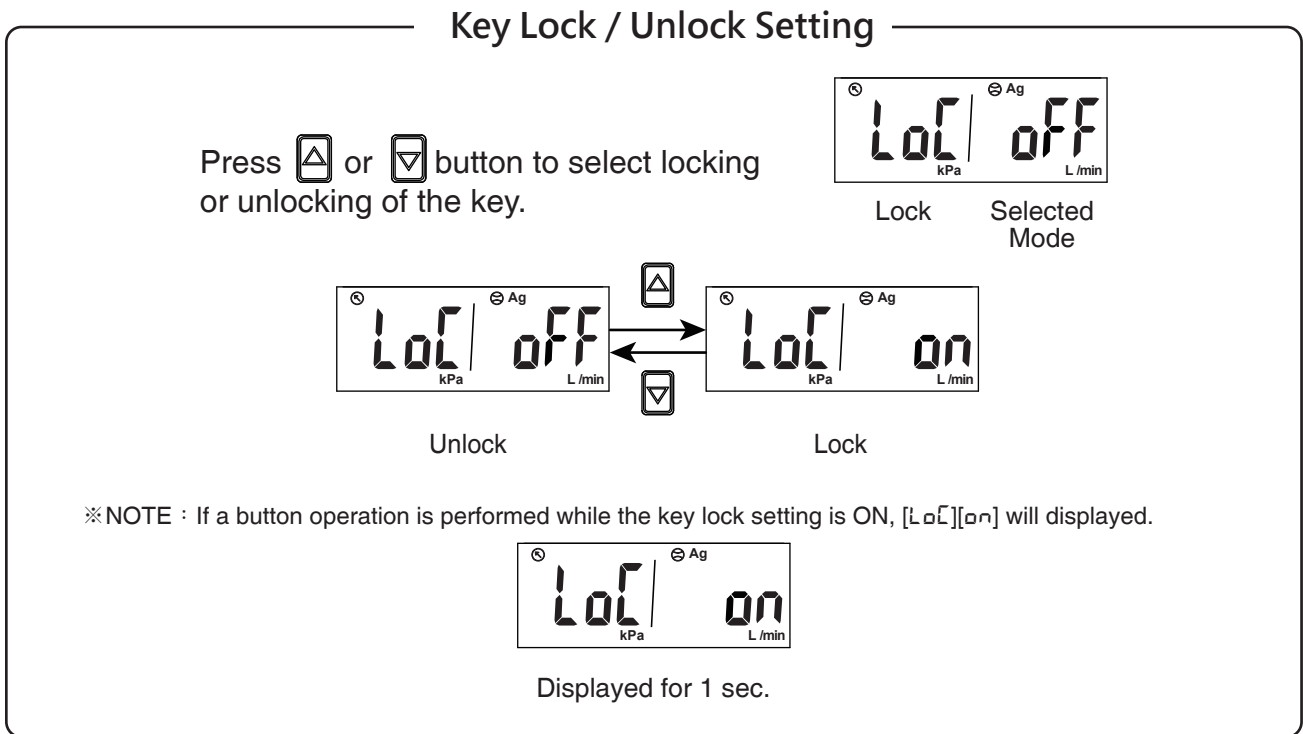

3 Modbus RTU Instruction









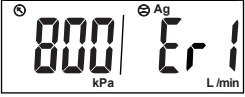

Function Code	Explanation	Operation
0000H	ID Number (0 ~ 255) Range : 0 ~ 255	Read Write
0001H	Baud rate setting 0 : 9600 bps 1 : 19200 bps 2 : 38400 bps	Read Write
0002H	Transmission format setting 0 : N.8.1 1 : E.8.1 2 : O.8.1	Read Write
0003H	Communications protocol setting 0 : RTU	Read Write
0004H	Measured flow rate range 7 : 500L/min 8 : 1000L/min 9 : 2000L/min	Read
0005H	Instantaneous flow value	Read
0006H	Flow unit 0 : LPM (L/min or mL/min) 1 : CFM(ft ³ /min)	Read Write
0007H	Decimal place for flow value 0: None 1 : One decimal place 0.1 2 : Two decimal places 0.01 3 : Three decimal places 0.001	Read
0008H	Accumulated flow value (ADL) XXXX 9999	Read
0009H	Accumulated flow value (ADH) 9999 XXXX	Read
000AH	Flow reference standard 0 : ANR (Standard condition) 1 : NOR (Normal condition)	Read Write
000BH	Flow sensor display mode 0 : Instantaneous flow 1 : Accumulated flow	Read Write
000CH	Accumulated value hold 0 : None 1 : 2min /times 2 : 5min/times	Read Write

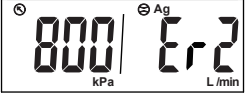
Function Code	Explanation	Operation
000DH	Flow display refresh time 0 : 200ms 1 : 500ms 2 : 1000ms	Read Write
000EH	Rated pressure range 3 : -0.100 ~ 1.000 MPa	Read
000FH	Display pressure value	Read
0010H	Pressure unit 0 : kPa 1 : Kg/cm ² 2 : bar 3 : psi	Read Write
0011H	Decimal place for pressure value 1 : One decimal place 0.1 2 : Two decimal places 0.01 3 : Three decimal places 0.001	Read
0012H	Pressure display refresh time 0 : 200ms 1 : 500ms 2 : 1000ms	Read Write
0013H	Fine Adjustment Setting 0 : OFF 1 : FLOW SENSOR 2 : PRESSURE SENSOR	Read Write
0014H	Fine adjustment of display value -25 ~ 25 (-2.5% ~ +2.5%)	Read Write
0015H	Response time of flow sensor 0 : 50ms 1 : 80ms 2 : 120ms 3 : 200ms 4 : 400ms 5 : 800ms 6 : 1500ms	Read Write
0016H	Response time of pressure sensor 0 : 2.5ms 1 : 25ms 2 : 100ms 3 : 250ms 4 : 500ms 5 : 1000ms 6 : 1500ms	Read Write

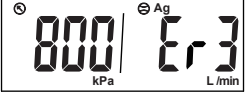
Function Code	Explanation	Operation
0017H	OUT1 corresponding sensor 0 : FLOW SENSOR 1 : PRESSURE SENSOR	Read Write
0018H	OUT1 output mode FLOW PRESSURE 0 : HYS 0: OPS 1 : WIN 1: HYS 2 : ADD 2: WIN 3 : PLS	Read Write
0019H	OUT1 output type 0 : N.O. mode 1 : N.C. mode	Read Write
001AH	Flow setting value FL-1	Read Write
001BH	Flow setting value FH-1	Read Write
001CH	Flow setting value ADL1	Read Write
001DH	Flow setting value ADH1	Read Write
001EH	Fixed hysteresis setting for flow value HYS 0 ~ 8	Read Write
001FH	Pressure setting value P-1 or L-1	Read Write
0020H	Pressure setting value H-1	Read Write
0021H	Fixed hysteresis setting for pressure value HYS 0 ~ 8	Read Write
0022H	OUT1 switch 0 : OFF 1 : ON	Read
0023H	OUT2 corresponding sensor 0 : FLOW SENSOR 1 : PRESSURE SENSOR	Read Write
0024H	OUT2 output mode FLOW PRESSURE 0 : HYS 0: OPS 1 : WIN 1: HYS 2 : ADD 2: WIN	Read Write
0025H	OUT2 output type 0 : N.O. mode 1 : N.C. mode	Read Write
0026H	Flow setting value FL-2	Read Write
0027H	Flow setting value FH-2	Read Write

Function Code	Explanation	Operation
0028H	Flow setting value ADL2	Read Write
0029H	Flow setting value ADH2	Read Write
002AH	Fixed hysteresis setting for flow value HYS 0 ~ 8	Read Write
002BH	Pressure setting value P-2 or L-2	Read Write
002CH	Pressure setting value H-2	Read Write
002DH	Fixed hysteresis setting for pressure value HYS 0 ~ 8	Read Write
002EH	OUT2 switch 0 : OFF 1 : ON	Read
002FH	Color display for OUT1 or OUT2 selection 0 : OUT1 1 : OUT2	Read Write
0030H	Display color setting 0 : SOG (Switch on Green) 1 : SOR (Switch on Red) 2 : GRN (Always is Green) 3 : RED (Always is Red)	Read Write
0031H	Power-save mode 0 : NO 1 : YES	Read Write
0032H	Reset to the default setting 0: RECALL	Write
0033H	Instant flow zero adjustment 0 : When over $\pm 5\%$ F.S., error code 03H will show.	Write
0034H	Pressure zero adjustment 0 : When over $\pm 3\%$ F.S., error code 03H will show.	Write
0035H	Reset accumulated flow 0 : Accumulated flow value return to zero	Write
0036H	Key lock/unlock setting 0 : OFF 1 : ON	Read Write
0037H	Switch output 0 : NPN 1 : PNP	Read

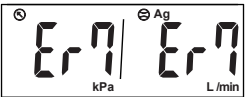
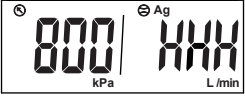
4 Error Code Instruction

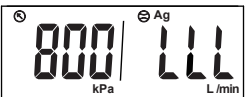
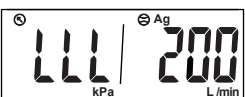
Error Type	Error Code	Error Condition	Troubleshooting
OUT1 Excess Load Current Error		Output 1 load current is more than 125 mA	Turn power off and check the cause of overload current or lower the current load under 125 mA, then restart.
			
OUT2 Excess Load Current Error		Output 2 load current is more than 125 mA	
			
Zero Adjustment Error		The instant flow is within $\pm 5\%$ F.S. of the zero point.	Perform the zero clear function again under no flow conditions.
		The pressure value is over $\pm 3\%$ F.S. of the zero point.	Perform the zero clear function again under no pressure conditions.
System Error		Memory error	Turn power off, and then restart. If error condition remains, please return to factory for inspection.
		Internal data error	
		Internal data error	
		System parameter error	
Applied Flow/Pressure Error		The instant flow has exceeded the upper limit of the flow display range.	Reduce the flow to the display range.
		The pressure has exceeded the upper limit of the pressure display range.	Reduce the pressure to the display range.
		The instant flow has exceeded the lower limit of the flow display range.	Ensure the flow is in the correct direction.
		The pressure has exceeded the lower limit of the pressure display range.	Reduce the pressure to the display range.

5 Specifications

Model		501	102	202	
Fluid		Dry air, N ₂ , Non-corrosive / Non-flammable gas			
Sensor Element	Flow	Measured flow rate range	2 ~ 500 L/min	5 ~ 1000 L/min	
	Flow	Flow Direction	Unidirection		
Sensor Element	Pressure	Rated Pressure Range	-90 ~ 1000 kPa		
			4 digital * 4 digital, 7 segment LCD display (Red / Green / Orange)		
Display	Instant Flow Rate	Display Range	0 ~ 525 L/min	0 ~ 1050 L/min	
		Minimum Setting Scale	LPM	1 L/min	
	Accumulated Flow	Display Range	99999999 L		
		Minimum Setting Scale	L	1 L	1 ft ³
	Pressure Display	Minimum Setting Scale	Display Range	-100 ~ 1000 kPa	
			kPa	1	
kgf/cm ²			0.01		
bar			0.01		
Accuracy	Flow	psi	0.1		
		Guaranteed Range	2 ~ 100 % F.S.		
Indicator Accuracy		± 3% F.S. ± 1 digit *1			
Analog Output Accuracy		± 5% F.S. *1			
Repeatability		± 1% F.S. ± 1 digit (± 2% F.S. when response time is set to 50 ms) *2			
Linearity		± 3% F.S. *2			
Accuracy	Pressure	Temp. Characteristic	± 5% F.S. (compare with *2)		
		Pressure Characteristic	± 5% F.S. ± 1 digit *3		
		Guaranteed Range	0 ~ 100 % F.S.		
	Pressure	Indicator Accuracy	± 2% F.S. ± 1 digit *4		
		Analog Output Accuracy	± 2.5% F.S. *4		
		Repeatability	± 0.2% F.S. ± 1 digit *4		
Linearity	± 1% F.S. *4				
Temp. Characteristic	± 2% F.S. (compare with *4)				
Switch Output			2NPN : open collector 2 outputs Max. Load Current : 125 mA Max. Supply Voltage : 28 V DC Voltage Drop : ≤ 1.5 V	2NPN : open collector 2 outputs Max. Load Current : 125 mA Max. Supply Voltage : 24 V DC Voltage Drop : ≤ 1.5 V	
	Response Time	Flow	800 ms (50 ms, 80 ms, 120 ms, 200 ms, 400 ms, 1500 ms selectable)		
		Pressure	2.5 ms (25 ms, 100 ms, 250 ms, 500 ms, 1000 ms, 1500 ms selectable)		
	Output Mode	Flow	Hysteresis Mode, Window Comparator Mode, Accumulated Output, Accumulated Pulse Output		
		Pressure	One Point Set Mode, Hysteresis Mode, Window Comparator Mode		
	Hysteresis		Adjustable		
Output Short Circuit Protection		Yes			
Accumulated Pulse Output		5 L/Pulse 20 ft ³ /Pulse	10 L/Pulse 40 ft ³ /Pulse	10 L/Pulse 40 ft ³ /Pulse	
Analog Output	Voltage Output		Voltage Output Range : 1 ~ 5 V *5 Output Impedance : 1 kΩ		
	Current Output		Voltage Output Range : 4 ~ 20mA *5 Load Impedance : ≤ 300 Ω		
	Response Time		Pressure : ≤ 50 ms ; Flow : ≤ 100 ms		
External Input		Non-voltage input , ≤ 0.4 V , ≥ 30 ms			
Communication interface		RS-485 *6			
Power	Power Supply Voltage		12 ~ 24V DC ± 10 % · Ripple (P-P) ≤ 10 %		
	Current Consumption		≤ 50 mA		
Environment	Withstand Pressure		1.5 MPa		
	Enclosure		IP40		
	Working Fluid Temp.		0 ~ 50°C (No condensation or freezing)		
	Ambient Temp. Range		Operation : 0 ~ 50°C ; Storage : -10 ~ 60°C (No condensation or freezing)		
	Ambient Humidity Range		Operation / Storage : 35 ~ 85 % R.H. (No condensation)		
	Insulation Resistance		≥ 2 MΩ (50V DC , between case and lead wire)		
	Withstand Voltage		250V AC 1-min (between case and lead wire)		
Vibration		Total amplitude 1.5 mm or 10 G, 10Hz - 55Hz - 10Hz scan for 1 minute, 2 hours each direction of X, Y and Z			
Shock		100 m/s ² (10 G) , 3 times each in direction of X, Y and Z			
EMC		IEC 61000-6-2, IEC 61000-6-4			
Lead Wire		Ø4 Oil-resistance cable - 26 AWG (0.15 mm ²) - 6 cores			
Port Size	Rc1/2 · G1/2	●	●	●	
	Rc3/4 · G3/4				
Weight (with 2 Meter Lead Wire)		250 g	250 g	325 g	

NOTE :

*1 : CONDITION : Inlet Pressure : 300 kPa , Outlet Pressure : 1 atmospheric pressure, 25 °C.

*2 : CONDITION : Outlet Pressure : 1 atmospheric pressure, 25 °C.

*3 : 0 ~ 1.0 MPa, Outlet Pressure : 1 atmospheric pressure, 25 °C.

*4 : Outlet flow rate = 0 L/min, 25 °C.

*5 : PWM output, corresponding to pressure sensor 0 ~ 1000 kPa.

*6 : This function only available for Output Specification -02 and -04.

6 Pressure Loss Characteristics

● KFP02-501 (500 L/min)

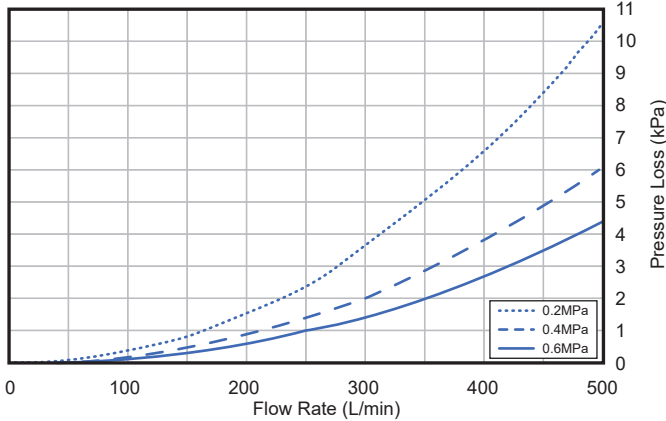

● KFP02-102 (1000 L/min)

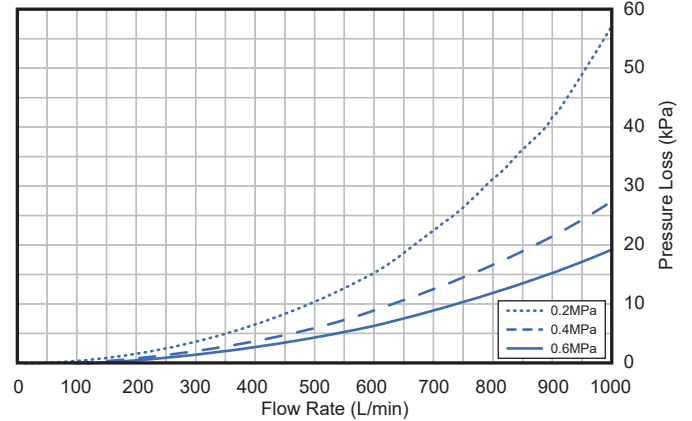

● KFP02-202 (2000 L/min)

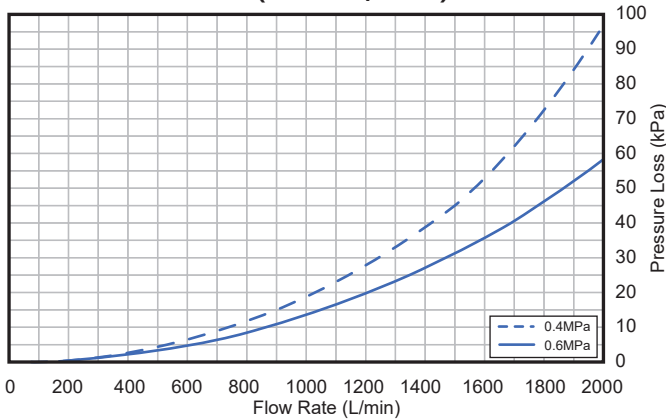

7 Thermal Mass Flow Sensor Principles

Symmetric Temperature Profile No Flow

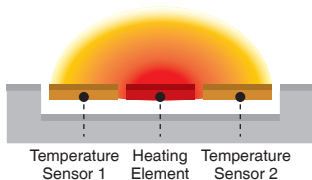

(a) : No Flow

In the absence of flow, the heat from the heater spreads evenly left and right, so the temperature distribution is like (a).

Skewed Temperature Profile Small Flow

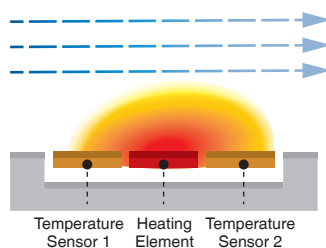

(b) : Small Flow

When flow begins, the inlet side is cooled by the flow, the outlet side is warmed by the heat of the inlet side of the heater, and the temperature distribution is like (b).

Skewed Temperature Profile Large Flow

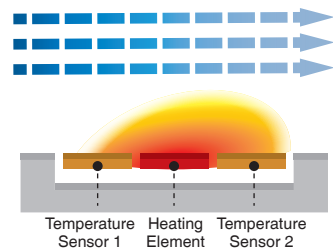

(c) : Large Flow

When the flow increases, it becomes a distribution like (C). Since the temperature distribution before and after the heater is proportional to the flow rate, the flow rate can be determined from the ratio.

8 ORDERING INFORMATION

K F P 0 2 - 5 0 1 - 0 1 0 - F 7 C

Flow Rate Range

501 : 500 L/min
102 : 1000 L/min
202 : 2000 L/min

Output Specifications

010 : 2 NPN output + Analog output 1~5V
011 : 2 NPN output + Analog output 4~20mA
02 : 2 NPN output + RS485
030 : 2 PNP output + Analog output 1~5V
031 : 2 PNP output + Analog output 4~20mA
04 : 2 PNP output + RS485

Port Size

F7C : Rc1/2, for Flow Rate Range 501, 102.
F9C : G1/2, for Flow Rate Range 501, 102.
F10C : Rc3/4, for Flow Rate Range 202.
F12C : G3/4, for Flow Rate Range 202.

Optional Parts

BT-27 : Mounting bracket, for Flow Rate Range 501, 102.
BT-28 : Mounting bracket, for Flow Rate Range 202.

9 Dimensions

1. Product

- Flow Rate Range 501, 102
(Port Size : Rc $\frac{1}{2}$, G $\frac{1}{2}$)

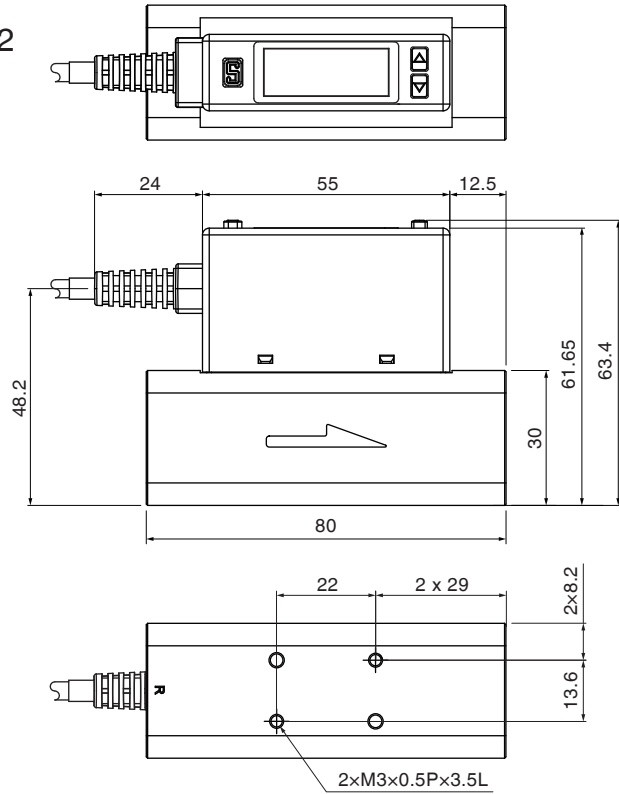
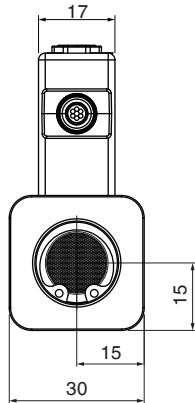

- Flow Rate Range 202
(Port Size : Rc $\frac{3}{4}$, G $\frac{3}{4}$)

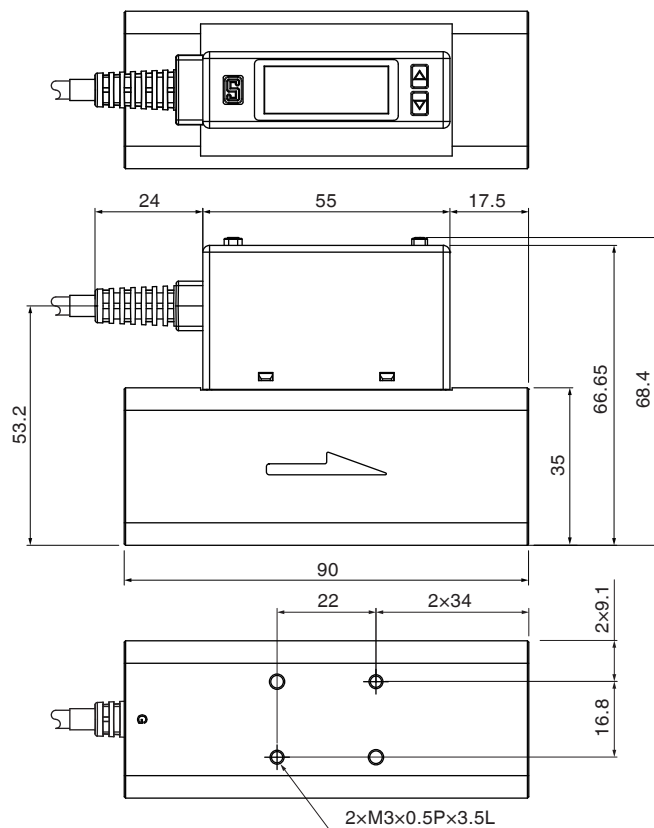
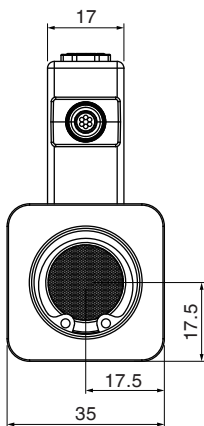

Unit : mm

2. Mounting Bracket

● Flow Rate Range : 501, 102

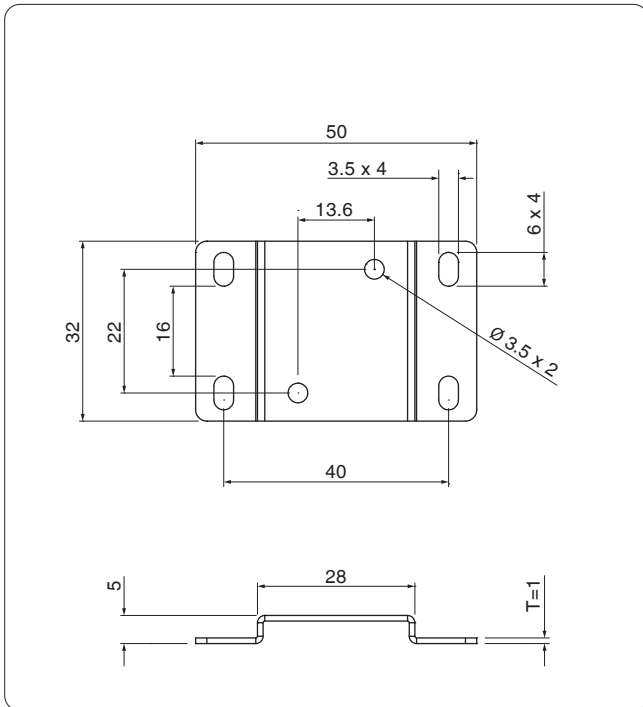

● Flow Rate Range : 202

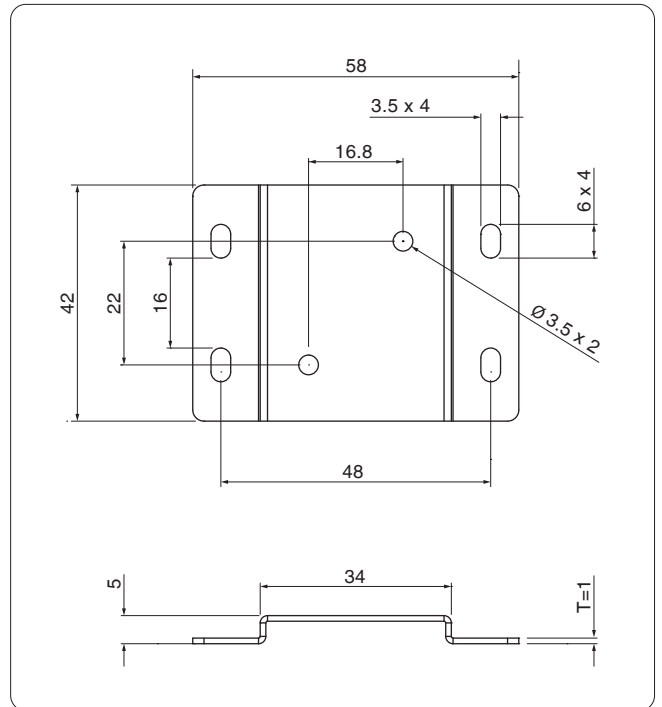

Unit : mm

10 Construction

