

For your safety, please read the following before using.

- ① Do not use corrosive or flammable gas or liquid with this product.
- ② Please use within the rating pressure range. Do not apply pressure beyond recommended maximum withstand pressure, permanent damage to the pressure sensor may occur.
- ③ Do not drop, hit or allow excessive shock. Even if switch body appears undamaged, internal components may be broken and can cause malfunction.
- ④ Turn power off before connecting wiring. Wrong wiring or short circuit will damage and/or cause malfunction.
- ⑤ Do not use in environment containing steam or oil vapor.
- ⑥ This product is not explosion-proof rated. Do not use in atmosphere containing flammable or explosive gases.
- ⑦ Wiring for pressure sensor should avoid power source line and high voltage line. If use in the same circuit, noise may cause malfunction.
- ⑧ For Use on a Flat Surface of a Type 1 Enclosure.
- ⑨ Sensors at end-of-life must be disposed of in accordance with E-Waste regulations of the country/region, NOT disposed of with regular garbage.

A SPECIFICATIONS

MODEL		KP45P-□-□ (Positive Pressure)	KP45V-□-□ (Vacuum Pressure)	KP45C-□-□ (Compound Pressure)
Rated pressure range		0.000 ~ 1.000MPa	0.0 ~ -101.3kPa	-100.0 ~ 100.0kPa
Setting pressure range		-0.100 ~ 1.000MPa	10.0 ~ -101.3kPa	-101.0 ~ 101.0kPa
Withstand pressure		1.5MPa	300kPa	
Fluid		Filtered air, Non-corrosive / Non-flammable gas		
Set pressure resolution	kPa	—	0.1	
	MPa	0.001	—	
	kgf/cm ²	0.01	0.001	
	bar	0.01	0.001	
	psi	0.1	0.01	
	inHg	—	0.1	
Power supply voltage		12 ~ 24V DC ±10%, Ripple (P-P) ≤10% (UL Class 2)		
Current consumption		≤ 40mA (With no load)		
Switch output		2 NPN : open collector 2 outputs Max. Load Current : 125 mA Max. Supply Voltage : 30V DC Residual Voltage : ≤ 1.5 V	2 PNP : open collector 2 outputs Max. Load Current : 125 mA Max. Supply Voltage : 24V DC Residual Voltage : ≤ 1.5 V	
Repeatability		± 0.2 % F.S. ± 1 digit		
Hysteresis	One point set mode	Adjustable (*1)		
	Hysteresis mode			
	Window comparator mode			
Response time		≤ 2.5 ms (Chattering-proof function : 25 ms, 100 ms, 250 ms, 500 ms, 1000 ms and 1500 ms selectable)		
Output short circuit protection		Yes		
Display		3 ½ digital, 7 segment LCD display (Red / Green / Orange) (Sampling rate : 5 times / sec.)		
Indicator accuracy		± 2 % F.S. ± 1 digit (Ambient temperature : 25 ± 3 °C)		
Switch on indicator		Orange Indicator 1 : OUT1 & Orange Indicator 2 : OUT2		
Analog output (Voltage output)		Output Voltage : 1 ~ 5 V ± 2.5 % F.S. (within rated pressure range) Linearity : ± 1 % F.S. Output Impedance : about 1 kΩ		
Analog output (Current output)		Output Current : 4 ~ 20 mA ± 2.5 % F.S. (within rated pressure range) Linearity : ± 1 % F.S. Max. Load Impedance : 250 Ω at power supply of 12 V , 600 Ω at power supply of 24 V Min. Load Impedance : 50 Ω		
Environment	Enclosure	IP65 (*2)		
	Ambient temp. range	Operation : 0 ~ 50 °C, Storage : -10 ~ 60 °C (No condensation or freezing)		
	Ambient humidity range	Operation / Storage : 35 ~ 85 % RH (No condensation)		
	Withstand voltage	1000V AC in 1-min (between case and lead wire)		
	Insulation resistance	≥ 50 MΩ (at 500 V DC, between case and lead wire)		
	Vibration	Total amplitude 1.5 mm or 10 G, 10 Hz ~ 55 Hz ~ 10 Hz scan for 1 minute, 2 hours each direction of X, Y and Z		
	Shock	100 m/s ² (10 G), 3 times each in direction of X, Y and Z		
Temperature characteristic		± 2 % F.S. of detected pressure (25 °C) at temp. (Range of 0 ~ 50 °C)		
Port size		F1 : R1/8", M5 ; F2 : NPT1/8", #10-32 UNF ; F3 : G1/8" (BSPP), M5 F1C : Rc1/8" ; F2C : NPT1/8" ; F3C : G1/8" (BSPP)		
Lead wire		Ø4 Oil-resistance cable (PVC) - 26 AWG (0.15 mm ²) - 5 cores		
Weight (with 2 meter lead wire)		Approx. 90 g (Port F1 ~ F3) ; Approx. 112 g (Port F1C ~ F3C)		

*1. Hysteresis value is adjustable within 1 ~ 8 digits for one point set mode and window comparator mode.

*2. Dustproof protector must be installed to maintain IP65.

B ORDERING INFORMATION

K P 4 5 C - 0 1 0 - F 1

Pressure Range

C : Compound pressure (-101.0 ~ 101.0 kPa)
 V : Vacuum pressure (10.0 ~ -101.3 kPa)
 P : Positive pressure (-0.100~1.000 MPa)

Output Specifications

010 : 2 NPN + Analog (Voltage) output (1~5V)
 011 : 2 NPN + Analog (Current) output (4~20mA)
 02 : 2 NPN + Copy function
 030 : 2 PNP + Analog (Voltage) output (1~5V)
 031 : 2 PNP + Analog (Current) output (4~20mA)
 04 : 2 PNP + Copy function

Pressure Port

F1 : R1/8", M5 ,with external threads
 F2 : NPT1/8", #10-32UNF ,with external threads
 F3 : G1/8"(BSPP), M5 ,with external threads
 F1C : Rc1/8" ,with internal threads
 F2C : NPT1/8" ,with internal threads
 F3C : G1/8"(BSPP) ,with external threads

Optional Parts

BT-10 : Mounting bracket (for Pressure Port F1~F3)
 BT-11 : Mounting bracket (for Pressure Port F1~F3)
 BT-1 : Mounting bracket (for Pressure Port F1C~F3C)
 BT-17 : Mounting bracket (for Pressure Port F1C~F3C)
 PA-E : Panel adapter
 PA-F : Panel adapter + Front protective lid

C PANEL DESCRIPTION

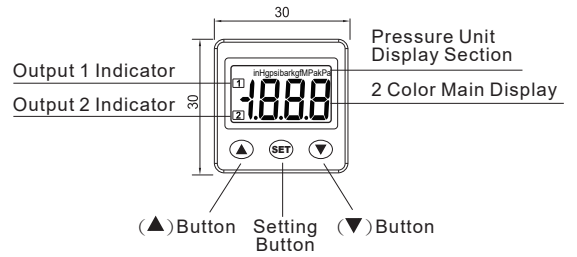

D OUTPUT CIRCUIT WIRING DIAGRAMS

KP45 □ -010- □

2 NPN+Analog Output (1~5V)

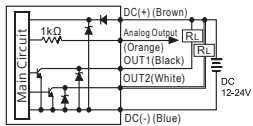

KP45 □ -030- □

2 PNP+Analog Output (1~5V)

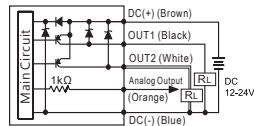

KP45 □ -011- □

2 NPN+Analog Output (4~20mA)

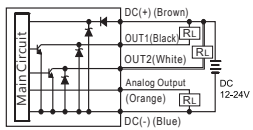

KP45 □ -031- □

2 PNP+Analog Output (4~20mA)

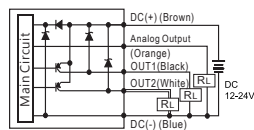

KP45 □ -02- □

2 NPN+Copy Function

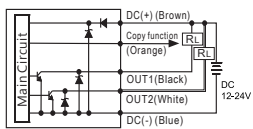

KP45 □ -04- □

2 PNP+Copy Function

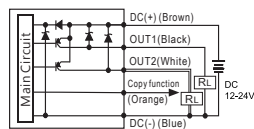

E DIMENSIONS

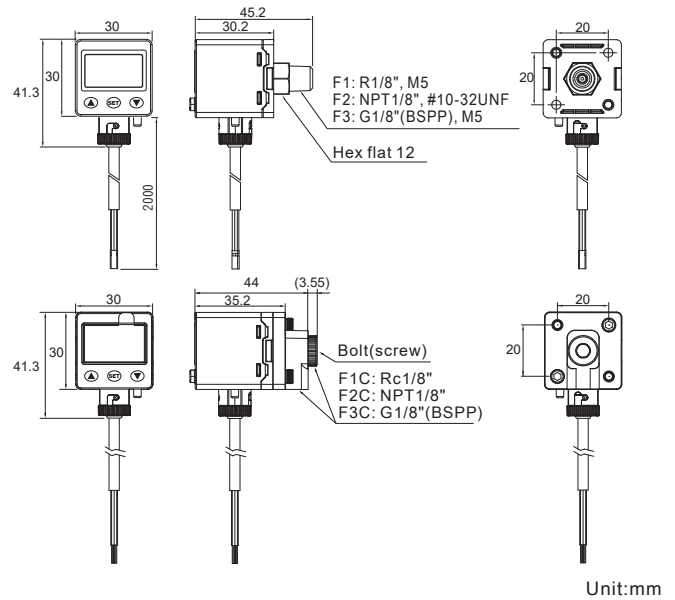

F OPTIONAL PARTS DIMENSIONS

① Mounting bracket

BT-10

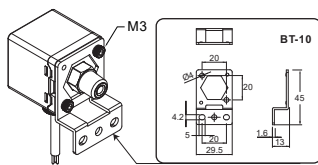

BT-1

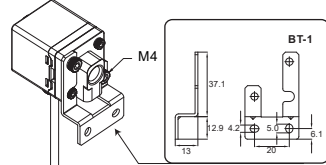

BT-11

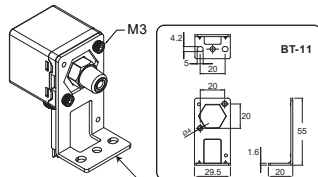

BT-17

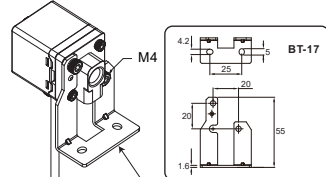

③ Accessory

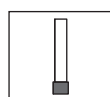
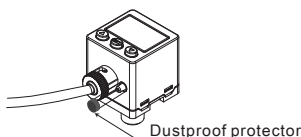

Caution :
 This device must be installed to maintain IP 65 (Dust and splash proof) enclosure rating.

② Panel Mounting

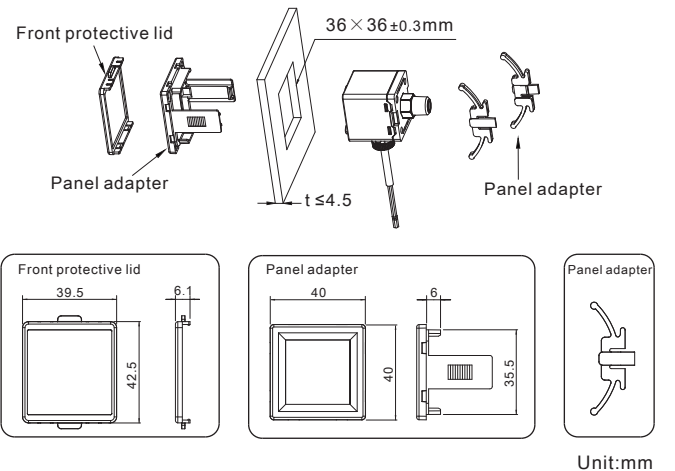

④ Accessory for pressure port F1C~F3C

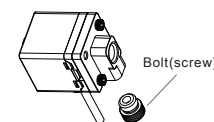

1. This product has two inlet pressure ports, select the one most convenient for installation.
2. Please plug the unused inlet port with supplied port plug. Use seal tape to prevent pressure leak.

G INITIAL SETTING MODE

H ADVANCE SETTING MODE

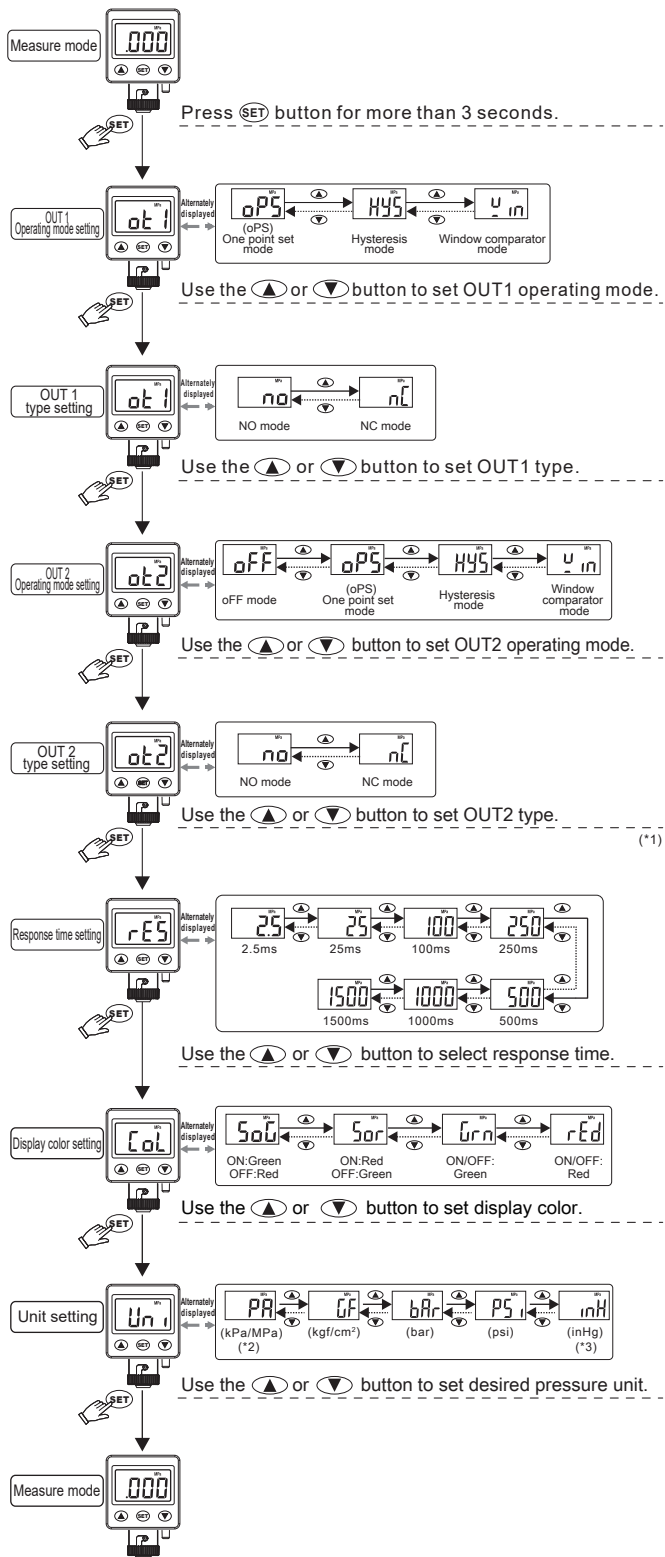

[NOTE :]
 *1. This setting mode will not display when output 2 is set to oFF.
 *2. Pressure unit is MPa with positive pressure.
 Pressure unit is kPa with vacuum and compound pressure.
 *3. Only applicable for Vacuum/Compound.

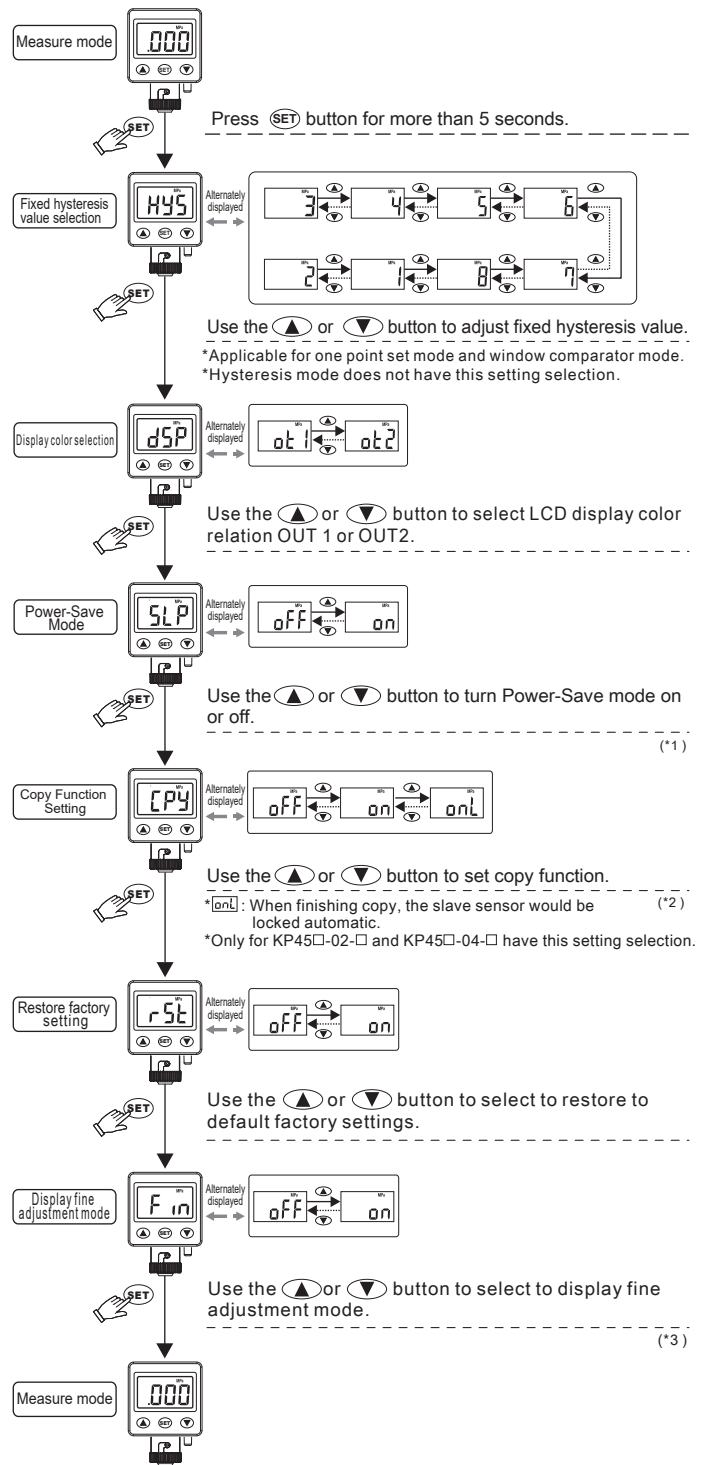

[NOTE :]
 *1. When setting is "on", the power-save mode is active. Please refer to the item " " in detailed.
 *2. When setting is "on" or "onL", the display copy function mode is active. Please refer to the item " " in detailed.
 *3. When setting is "on", the display fine adjustment mode is active. Please refer to the item " " in detailed.

I POWER-SAVE MODE

- During Power-Save mode, the main display will turned off if no buttons is pressed after 30 seconds.
- During Power-Save mode, the output LCD may not be synchronize with the output. It is normal and will not affect output operation.
- Press any button to turn-on main display temporarily.

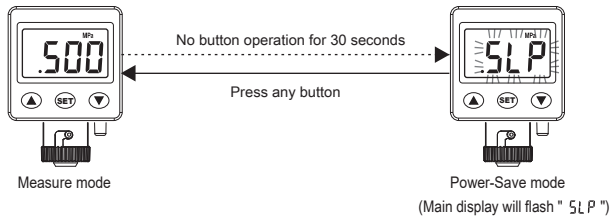

J PRESSURE SETTING MODE

- One point set mode :
- Hysteresis mode / Window comparator mode :

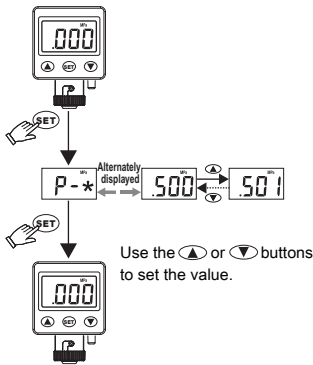

When out 1, "" displays 1
When out 2, "*" displays 2.

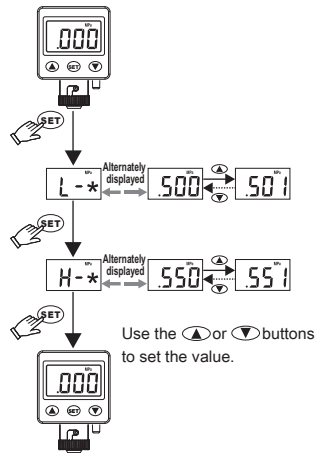

K OUTPUT TYPE

(1) One point set mode:

Normal open mode

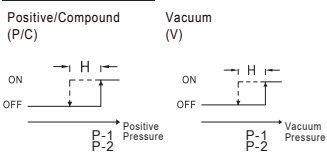

Normal close mode

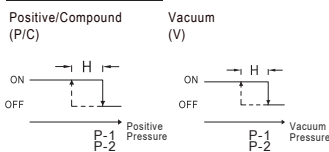

(2) Hysteresis mode:

Normal open mode

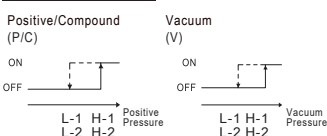

Normal close mode

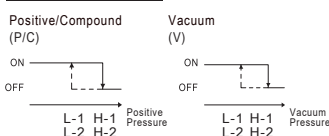

(3) Window comparator mode:

Normal open mode

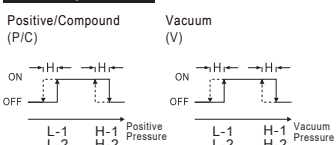

Normal close mode

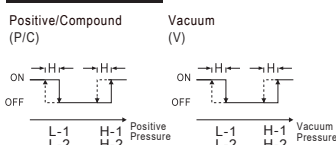

【 NOTE : 】

- *1. In case hysteresis is set as less than or equal to 2 digits, switch output may chatter if input pressure fluctuates near the set point.
- *2. When using window comparator mode, the difference between two set points must be greater than the fixed hysteresis, otherwise will cause the switch output to malfunction.

L ANALOG OUTPUT DESCRIPTION

Analog output range 1-5V or 4-20mA, proportional to the pressure range.

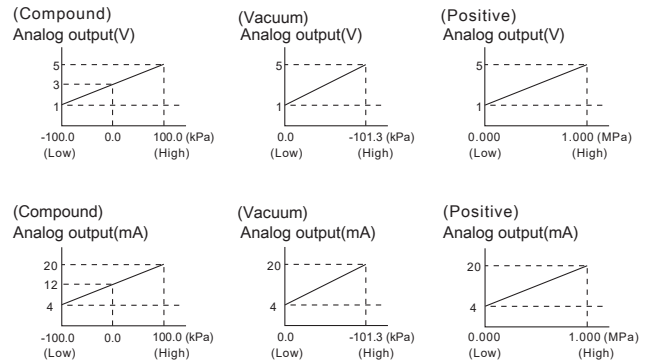

M ZERO POINT SETTING

Press the \blacktriangle + \blacktriangledown button at the same time until the "00" is shown.
Release the button to end zero setting.

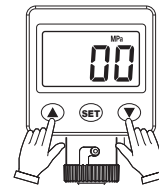

N THE MAX. & MIN. DISPLAY MODE

◎ The Max. value display mode :

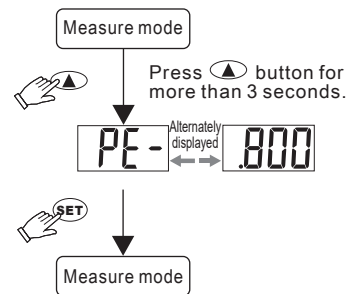

◎ The Min. value display mode :

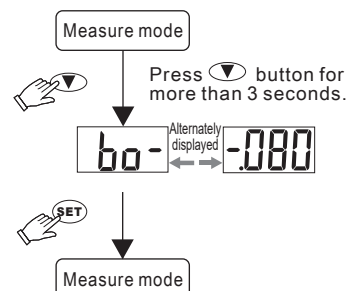

O KEY LOCK/UNLOCK MODE

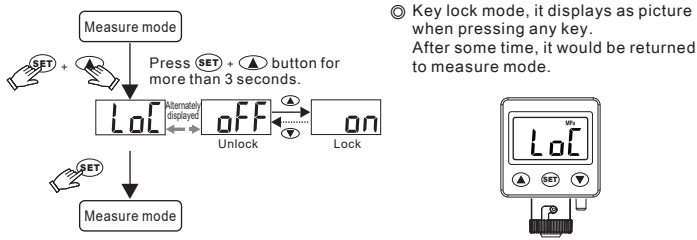

P WIRE INSTALLATION INSTRUCTION

Please install the wire as the following step.

- Turn upward the salient point by terminal. (See figure ①)
- Install to the terminal to the groove by pressure sensor. (See figure ②)
- Terminal cover install to the products. (See figure ③)
- Turn the terminal cover to lock. (See figure ④)

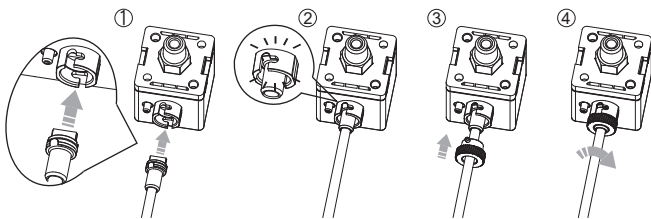

【NOTE:】 Recommend not insert-extract over 20 times.

Q COPY FUNCTION SETTING

- Copy function setting can use the master sensor to copy the pressure value to the slave sensors.
- Before copying, please confirm the model of pressure sensor. The function cannot use in difference mode.
- The copy function only can be one-to-one.

【SETTING STEP】

1. Please set the copy function to [on] or [on] to be on copy condition by master sensor. Please refer the copy setting of (H) advance setting mode.
2. Turn power off to both sensor.
3. Refer the connection way with the master and slave sensor as followings.

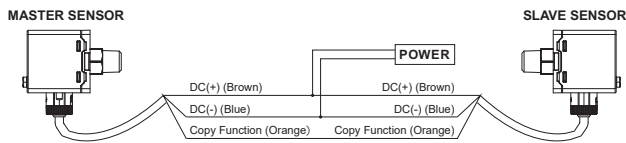

4. Turn on power at same time. (* 1)
5. Wait 5 sec., when finishing to convey the data, the master sensor display (alternately display) $\frac{E_{PV}}{L_{od}}$ (display reciprocal) the slave sensor display (alternately display) $\frac{SLv}{L_{od}}$ (display reciprocal)
6. When convey the data failed, (Master) sensor displays $\frac{E_{PV}}{L_{od}}$ (Slave) sensor displays $\frac{ErB}{L_{od}}$ (* 2)
7. Turn off power and remove the wire connection. If no remove the wire connection, the sensor would be broken.

- ★ If require to copy another slave sensor, please repeat the step ③ to ⑤ .
- ★ Only for KP45□-02-□ and KP45□-04-□ have this setting selection.

【NOTE】

- *1. If turn on power is not synchronization, the data cannot be copied.
- *2. When the data conveys failed, please check the wire connection. Then repeat the step ③ to ⑤ .

• How to cancel the copy mode :

When the master sensor display $\frac{E_{PV}}{L_{od}}$ (display reciprocal), Please \downarrow button to leave the copy mode.

R FINE ADJUSTMENT MODE

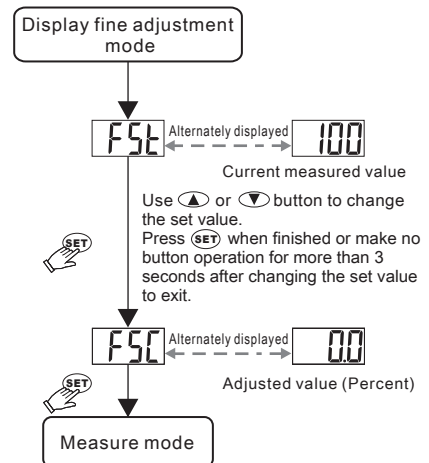

This function eliminates slight differences in the output values and allows uniformity in the numbers displayed. Displayed values of the pressure sensor can be calibrated to within $\pm 2.5\%$ R.D.

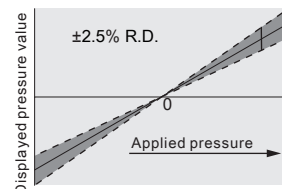

— :Factory setting display value set prior to shipment
 ■ :Display calibration range

R.D. (Real Detect)

- 【NOTE :】 1. Setting resolution is $\pm 0.1\%$ R.D.
- 2. The signal would be changed with analog output after adjusting.

S ERROR CODE INSTRUCTION

Error Type	Error code	Error Condition	Troubleshooting
Excess load current error	Er 1	Output 1 load current is more than 125 mA	Turn power off and check the cause of overload current or lower the current load under 125 mA, then restart.
	Er 2	Output 2 load current is more than 125 mA	
Residual pressure error	Er 3	During zero reset, ambient pressure is over $\pm 3\%$ F.S.	Change input pressure to ambient pressure and perform zero reset again.
Applied pressure error	HHH	Supply pressure exceeds the upper limit of pressure setting.	Adjust the pressure within operating pressure range.
	LLL	Supply pressure exceeds the lower limit of pressure setting.	
System error	Er 4	Internal system error	Turn power off, and then restart. If error condition remains, please return to factory for inspection.
	Er 5	Internal system error	
	Er 6	Internal data error	
	Er 7	Internal data error	
Copy data error	Er 8	Please check the model no. and wire connection. Restart to turn on power if no return to normal condition, please return to factory for inspection.	

T PRESSURE UNIT CONVERSION TABLE

From	To	Pa	kPa	MPa	kgf/cm ²	psi	bar	inHg
1 Pa		1	0.001	0.000001	0.000010197	0.000145038	0.00001	0.0002953
1 kPa		1000.000	1	0.001000	0.010197	0.145038	0.010000	0.2953
1 MPa		1000000	1000	1	10.197	145.038	10	295.298
1 kgf/cm ²		98066.5	98.0665	0.0980665	1	14.2233	0.980665	28.95979
1 psi		6895	6.895	0.006895	0.07031	1	0.06895	2.036074
1 bar		100000.0	100.0000	0.100000	1.01972	14.5038	1	29.5298
1 inHg		3386.388	3.386388	0.003386	0.034530	0.491141	0.033863	1