

ZECA

zeca.it

Avvolgitubo 8400

Hose reels 8400



NEW MODEL

**INOX
STAINLESS
STEEL**

SERIE 8400 • ANCORA PIÙ FLUIDI

SERIE 8400 • EVEN MORE FLUID

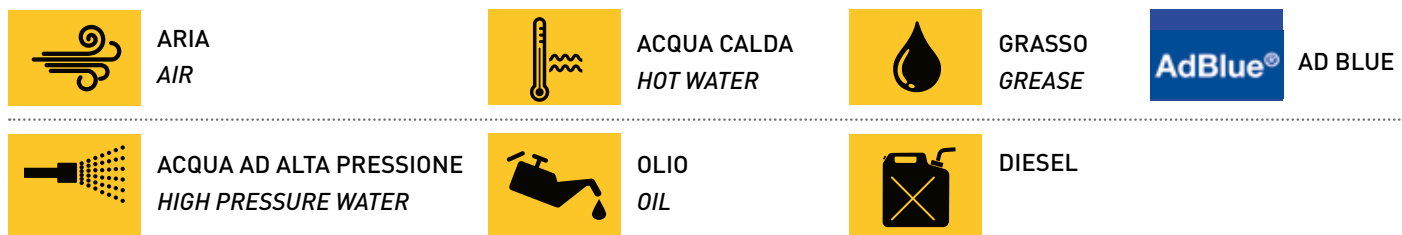
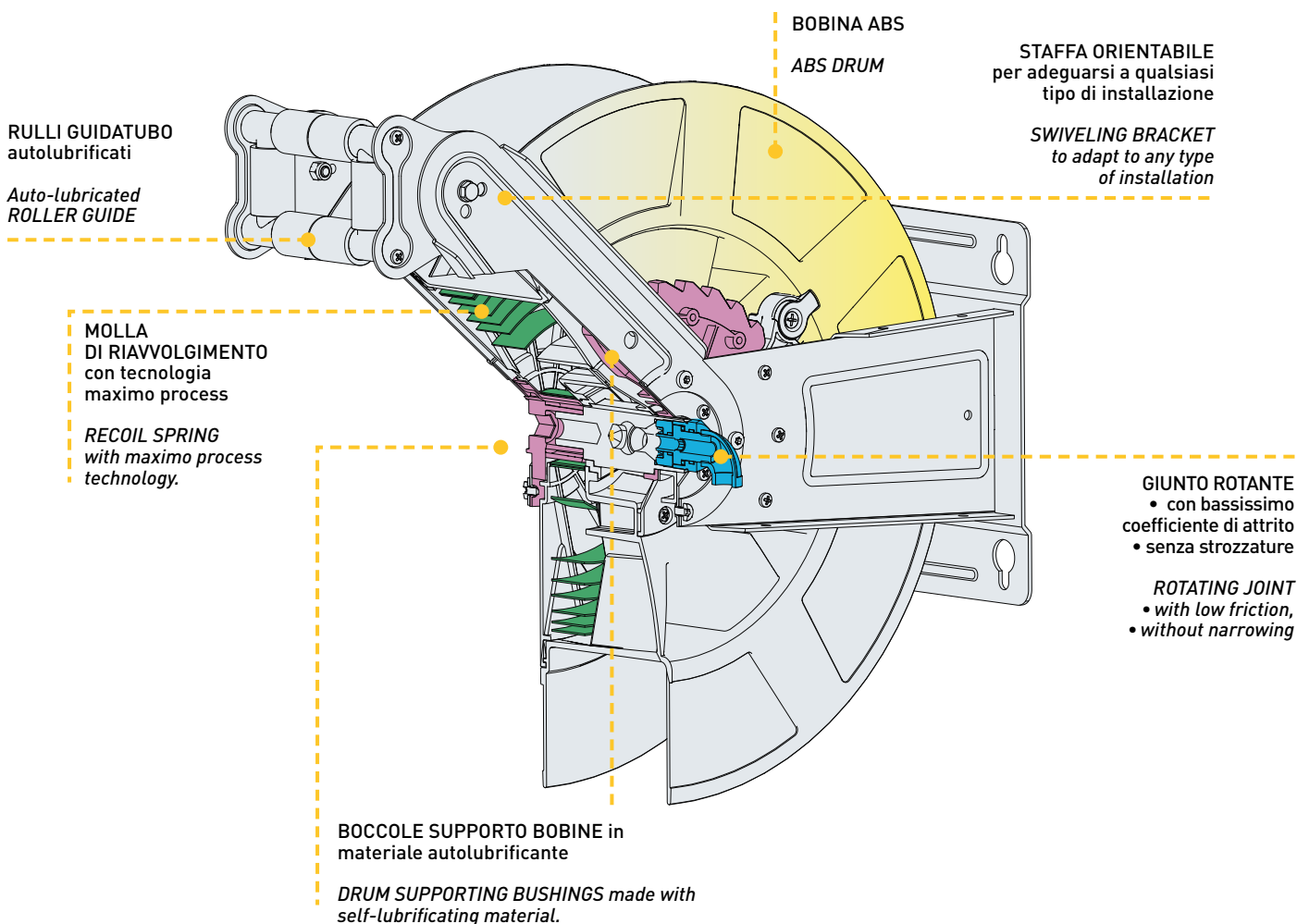

CAMPI DI APPLICAZIONE / FIELDS OF APPLICATION



SERIE 8400 FULL INOX/STAINLESS STEEL



- Staffa in acciaio INOX AISI 304
- *Bracket in stainless steel AISI 304*
- Giunto rotante e raccordo in entrata in acciaio INOX
- *Rotating joint and incoming fitting in stainless steel*

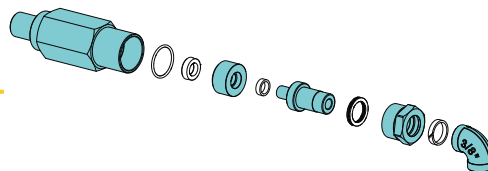

- Raccordo in uscita in acciaio INOX
- *End pipe fitting in stainless steel*
- Viterie in acciaio INOX
- *Screws and bolts in stainless steel*

SERIE 8400 LIGHT INOX/STAINLESS STEEL



- Staffa in acciaio INOX AISI 304
- *Bracket in stainless steel AISI 304*
- Giunto rotante e raccordo in entrata in ottone/acciaio/acciaio INOX
- *Rotating joint and incoming fitting in brass/steel/stainless steel*

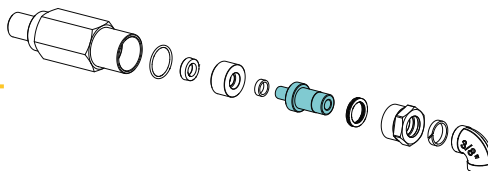

- Raccordo in uscita in ottone/acciaio
- *End pipe fitting in brass/steel*
- Viterie in acciaio INOX
- *Screws and bolts in stainless steel*

SERIE 8400



- Staffe in acciaio verniciato a polveri epossidiche.
- *Brackets in steel, painted with epoxy resin powders.*
- Giunto rotante e raccordo in entrata in ottone/acciaio/acciaio INOX
- *Rotating joint and incoming fitting in brass/steel/stainless steel*

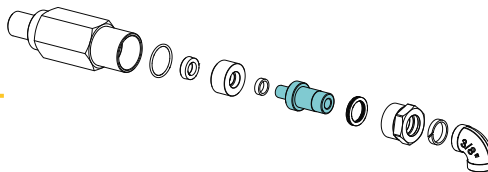

- Raccordo in uscita in ottone/acciaio
- *End pipe fitting in brass/steel*
- Viterie in acciaio
- *Screws and bolts in steel*

SERIE 8400 FULL INOX

SERIE 8400 FULL STAINLESS STEEL

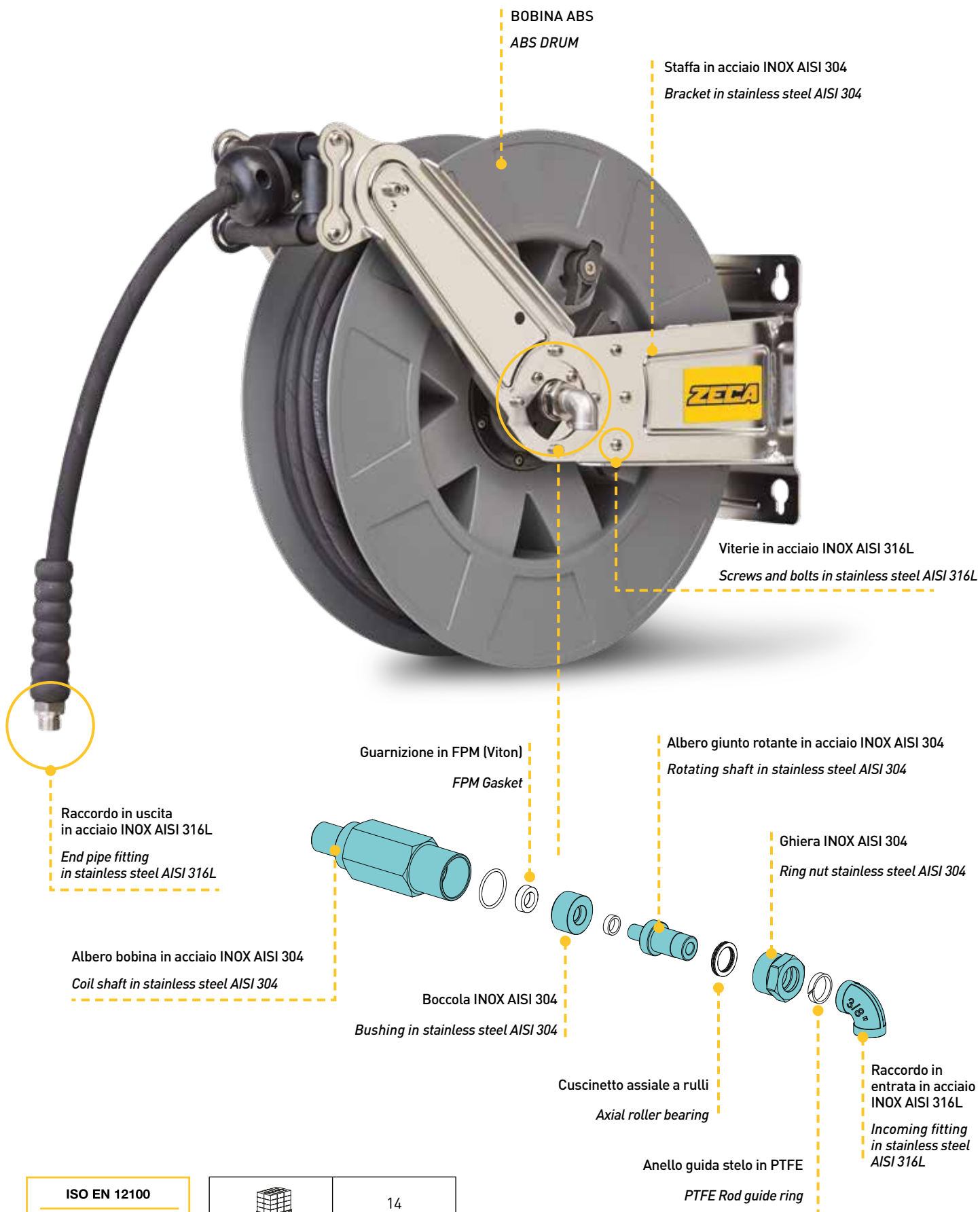

ISO EN 12100	
CE	
2006/42/CE	

	14
	mm 550x505x270 Kg 10

 Gli avvolgitubo Full INOX sono idonei in diversi campi di applicazione, dal settore alimentare, alla nautica e al settore chimico, ambienti di lavoro aggressivi e con atmosfere corrosive. Ideali per le pulizie industriali, operazioni di soffiaggio e trasporto fluidi come olio e AdBlue.

 The Full Stainless Steel hose reels are perfect for a variety of different applications, from the food and drink industry to the boating industry and the chemical sector, heavy duty work environments with corrosive atmosphere. They are the ideal for industrial cleaning, blowing operations and transport of fluids such as oil and AdBlue.

	Tipo tubo <i>Hose Type</i>	Tubo Hose \emptyset	Lungh. tubo <i>Hose length</i> (m)	Art.	Temperatura fluido <i>Fluid</i> <i>temperature</i>	Raccordo in uscita <i>End pipe fitting</i>	Raccordo in entrata <i>Incoming fitting</i>
ARIA - ACQUA AIR - WATER 20 bar	No tubo <i>No hose</i>	/	/	8401/1113	-15°C/+50°C	1/2" F	1/2" F
	SAE 100R6	10 mm 3/8"	12	8404/1111		3/8" M	
			18	8406/1111		1/2" F	
	KPU	12,5 mm 1/2"	15	8426/1111		1/2" M	
			20	8427/1111			
	ACQUA WATER 15 bar	PU - FOOD QUALITY*	12,5 mm 1/2"	12		8432/1111	
ADBLUE 15 bar	PVC -PU	19 mm 3/4"	8	8482/1111	-10°C/+60°C	3/4" F girevole / <i>swivelling</i>	3/4" M
OLIO - ACQUA OIL - WATER 200 bar	No tubo <i>No hose</i>	/	/	8440/1113	-15°C/+130°C	1/2" F	3/8" F
	EN857 1 SC Nero/Black	10 mm	15	8442/1111		3/8" F girevole / <i>swivelling</i>	
			18	8443/1111			
	EN 857 1SC Blu/Blue Non Marking	3/8"	15	8446/1111			
			18	8448/1111			

* NOTA: TUBO CERTIFICATO SECONDO REG. UE 1935/2004 E REG. UE 10/2011 IDONEO AL CONTATTO CON ALIMENTI. NON IDONEO AL PASSAGGIO DI LIQUIDI ALIMENTARI

NOTE: REG. UE 1935/2004 AND REG. UE 10/2011 CERTIFIED HOSE FOR USE IN THE FOOD INDUSTRY. NOT SUITABLE FOR FOOD LIQUIDS TRANSFER.

SERIE 8400 LIGHT INOX

SERIE 8400 LIGHT STAINLESS STEEL

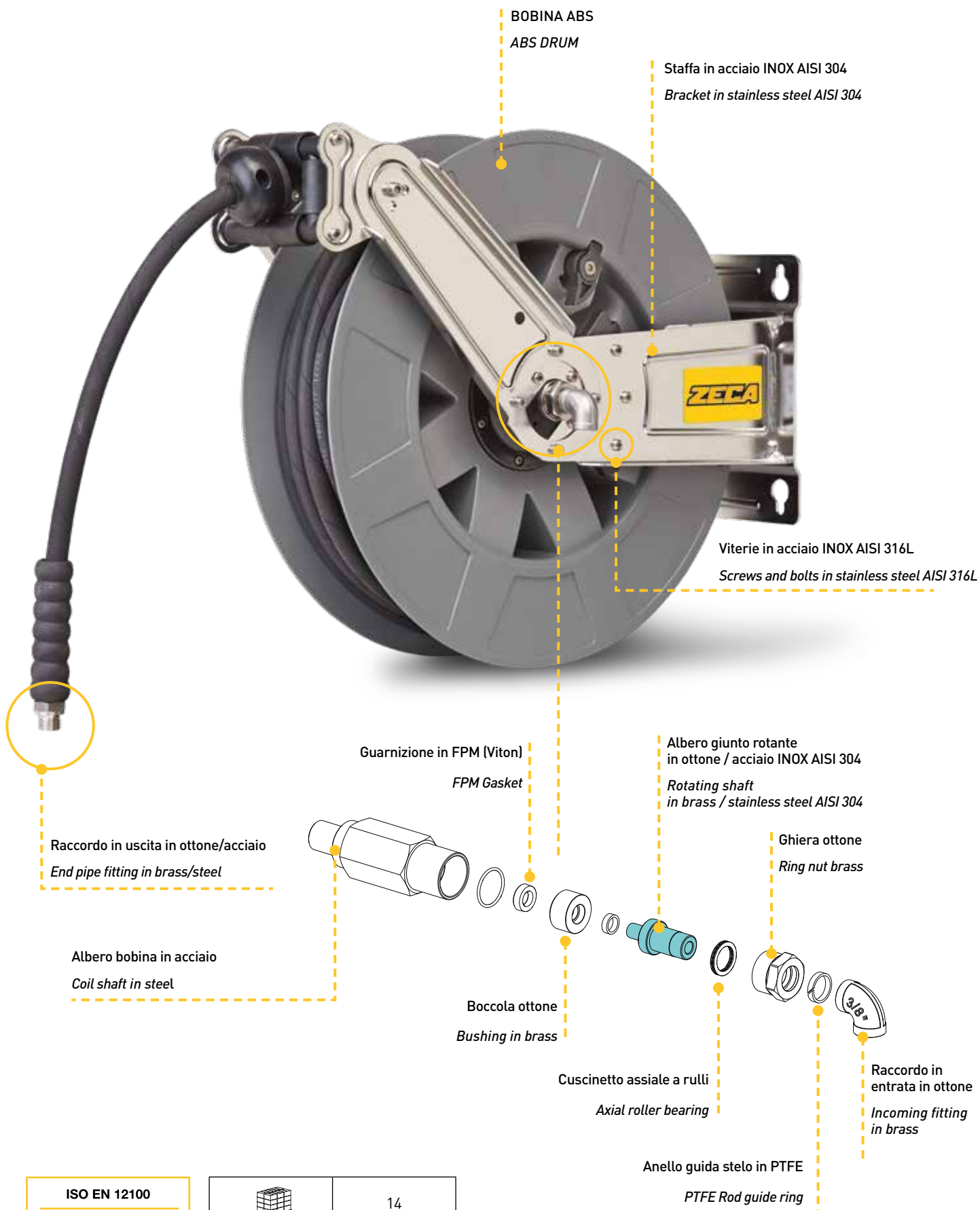

ISO EN 12100	
CE	
2006/42/CE	

	14
	mm 550x505x270 Kg 10



Gli avvolgtubo Light INOX sono idonei in diversi campi di applicazione, dal settore alimentare, alla nautica e al settore chimico, ambienti di lavoro aggressivi e con atmosfere corrosive. Ideali per le pulizie industriali, operazioni di soffiaggio e trasporto fluidi come olio.



The Light Stainless Steel hose reels are perfect to a variety of applications, from the food and drink industry to the boating industry and the chemical sector, heavy duty work environments with corrosive atmosphere. They are the ideal for industrial cleaning, blowing operations and transports of fluids such as oil.

	Tipo tubo <i>Hose Type</i>	Tubo Hose \emptyset	Lungh. tubo <i>Hose length</i> (m)	Art.	Temperatura fluido <i>Fluid</i> <i>temperature</i>	Raccordo in uscita <i>End pipe fitting</i>	Raccordo in entrata <i>Incoming fitting</i>
ARIA - ACQUA AIR - WATER 20 bar	No tubo <i>No hose</i>	/	/	8401/1003	-15°C/+50°C	1/2" F	1/2" F
	SAE 100R6	10 mm 3/8"	12	8404/1000		3/8" M	
			18	8406/1000			
	KPU	12,5 mm 1/2"	15	8426/1002		1/2" M	
			20	8427/1002			
	ACQUA WATER 15 bar	PU - FOOD QUALITY*	12,5 mm 1/2"	12		8432/1001	
OLIO - ACQUA OIL - WATER 200 bar	No tubo <i>No hose</i>	/	/	8440/1003	-15°C/+130°C	1/2" F	3/8" F girevole / <i>swivelling</i>
	EN857 1 SC Nero/ <i>Black</i>	10 mm	15	8442/1000		3/8" F	
			18	8443/1000			
	EN 857 1SC Blu/ <i>Blue</i> Non Marking	3/8"	15	8446/1000			
			18	8448/1000			

* NOTA: TUBO CERTIFICATO SECONDO REG. UE 1935/2004 E REG. UE 10/2011 IDONEO AL CONTATTO CON ALIMENTI. NON IDONEO AL PASSAGGIO DI LIQUIDI ALIMENTARI

NOTE: REG. UE 1935/2004 AND REG. UE 10/2011 CERTIFIED HOSE FOR USE IN THE FOOD INDUSTRY. NOT SUITABLE FOR FOOD LIQUIDS TRANSFER.

SERIE 8400 AVVOLGITUBO

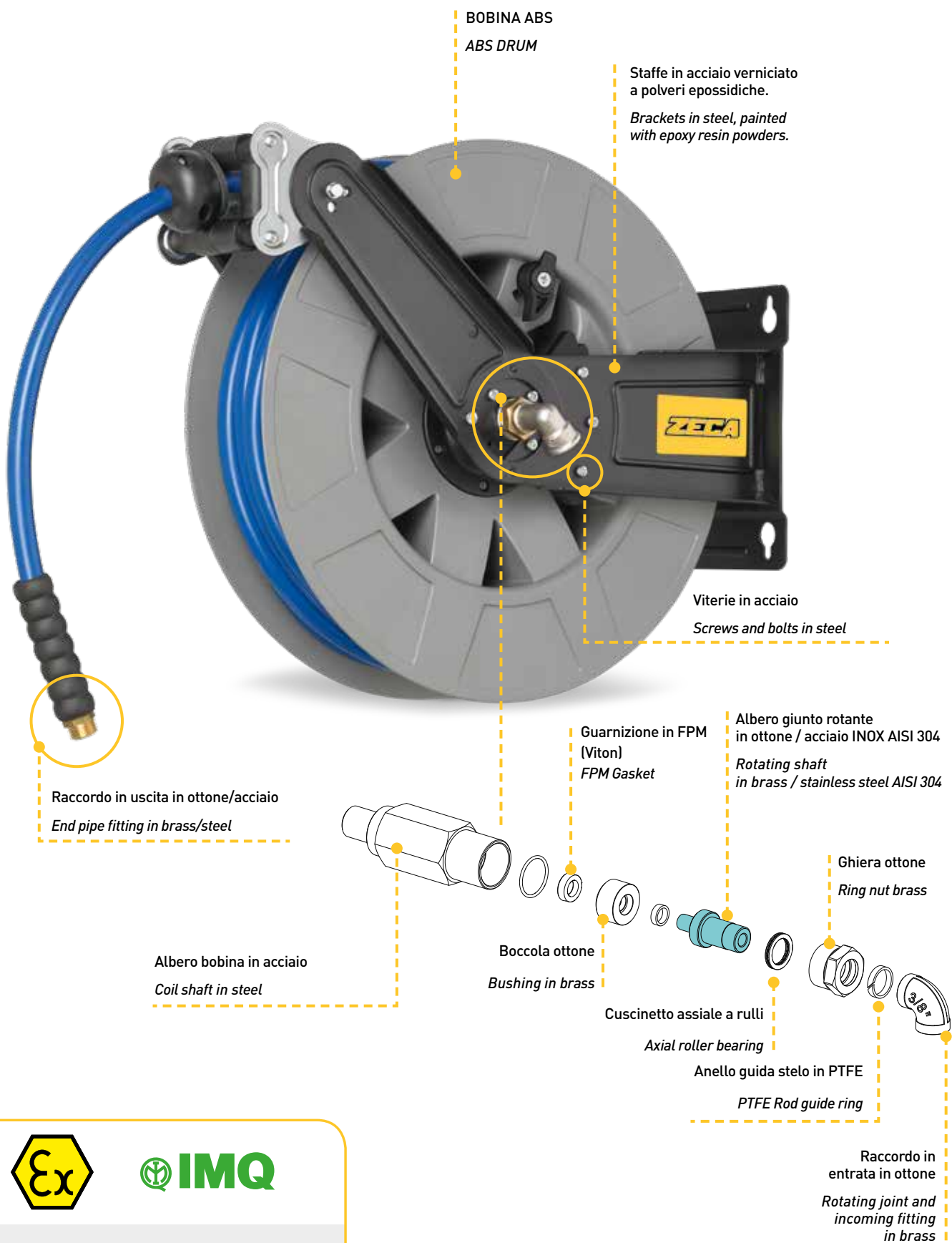

SERIE 8400 HOSE REEL



Compliance with Directive 2014/34/UE
 Marking **CE** II 2 GD c IIB T4/T135° C X
 Type Examination Certificate Number **IMQ 14 ATEX 009 X**
 Compliance with: **EN 13463-1 : 2009 | EN 13463-5 : 2011**

ISO EN 12100
CE
2006/42/CE

	14
	mm 550x505x270 Kg 10

	Tipo tubo Hose Type	Tubo Hose Ø	Lungh. tubo Hose length (m)	Art.		Temperatura fluido Fluid temperature	Raccordo in uscita End pipe fitting	Raccordo in entrata Incoming fitting	
ARIA - ACQUA AIR - WATER 20 bar	No tubo No hose	/	/	8401	/	-15°C/+50°C	1/2" F	1/2" F	
		/	/	8480	AISI 316L giunto / joint				
	SAE 100R6	6 mm 1/4"	20	8412	/				1/4" M
			8 mm 5/16"	20	8402				
		10 mm 3/8"	12	8404					3/8" M
			18	8406					
		12,5 mm 1/2"	10	8408					1/2" M
			15	8410					
	KPU	10 mm 3/8"	20	8424			3/8" M		
			15	8426					
		12,5 mm 1/2"	20	8427	1/2" M				
	ACQUA WATER 15 bar	PU - FOOD QUALITY*	12,5 mm 1/2"	12	8432		/		-10°C/+60°C
DIESEL - OLIO DIESEL - OIL 15 bar	PVC - PU	19 mm 3/4"	8	8415	/	-10°C/+60°C	3/4" F girevole swivelling	3/4" M	
AD BLUE 15 bar	PVC - PU	19 mm 3/4"	8	8482	AISI 316L giunto / joint	-10°C/+60°C	3/4" F girevole swivelling	3/4" M	
OLIO OIL 160 bar	EN 857 1SC	12,5 mm 1/2"	10	8474	/	-15°C/+120°C	1/2" F girevole swivelling		
OLIO-ACQUA OIL WATER 200 bar	No tubo No hose	/	/	8440	/	-15°C/+130°C	1/2" F	3/8" F	
	EN 857 1SC Nero / Black	8 mm 5/16"	20	8441	/				3/8" F girevole swivelling
			15	8442					
		10 mm 3/8"	18	8443					
			15	8446					
EN 857 1SC Blu / Blue Non Marking	18	8448							
OIL GREASE OLIO - GRASSO 400 bar	No hose No tubo	/	/	8460	/	-20°C/+120°C	1/2" F	3/8" F	
	EN857 2SC	6 mm 1/4"	12	8462	/		1/4" M		
			18	8463	/				

* NOTA: TUBO CERTIFICATO SECONDO REG. UE 1935/2004 E REG. UE 10/2011 IDONEO AL CONTATTO CON ALIMENTI. NON IDONEO AL PASSAGGIO DI LIQUIDI ALIMENTARI

NOTE: REG. UE 1935/2004 AND REG. UE 10/2011 CERTIFIED HOSE FOR USE IN THE FOOD INDUSTRY. NOT SUITABLE FOR FOOD LIQUIDS TRANSFER.

OPTIONAL SERIE 8400

COPERCHIO BOBINA / COIL COVER



8400/CY

Coperchio bobina giallo
Yellow coil cover



8400/CB

Coperchio bobina nero
Black coil cover

STAFFA ORIENTABILE / SWIVEL BRACKET



8400/SW

Staffa orientabile
Swivel bracket



8400/SWI

Staffa orientabile in acciaio INOX
Swivel bracket in stainless steel

INSTALLAZIONI POSSIBILI / POSSIBLE INSTALLATIONS

INSTALLAZIONE A PARETE / WALL INSTALLATION

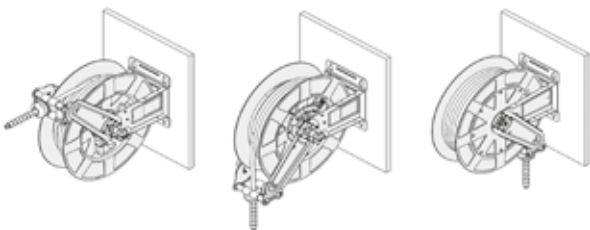

INSTALLAZIONE A SOFFITTO CEILING INSTALLATION

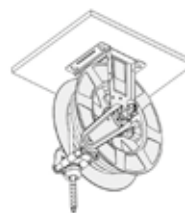

INSTALLAZIONE A BANCO BENCH INSTALLATION

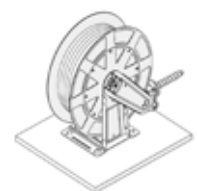

DIMENSIONS

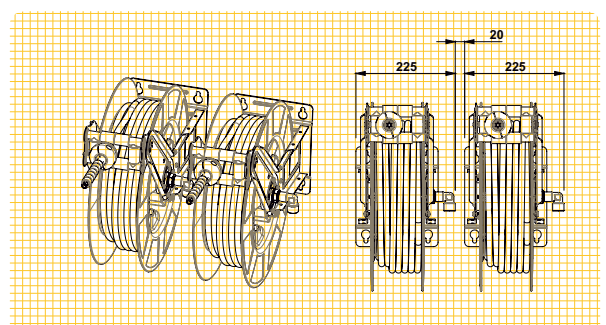
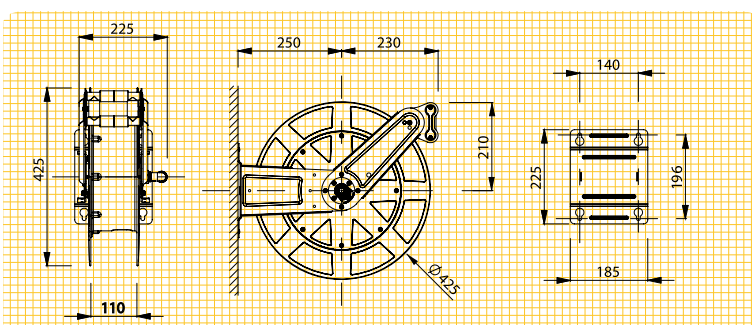

PISTOLE EROGAZIONE ACQUA BASSA PRESSIONE CON GETTO REGOLABILE

LOW PRESSURE WATER GUN WITH ADJUSTABLE SPRAY

ZETEK



	KPW050	KPW060	KPW060I
Materiale corpo <i>Material body</i>	PP + GF	PP + GF	PP + GF
Materiale pistone <i>Material piston</i>	Ottone / Brass	Ottone / Brass	Inox Aisi 316
Materiale guarnizione <i>Material gasket</i>	Viton	Viton	Viton
Portata massima <i>Max. flow rate</i>	50 l/min	60 l/min	60 l/min
Pressione nominale <i>Nominal pressure</i>	12 bar / 1.2 MPa	24 bar / 2.4 MPa	24 bar / 2.4 MPa
Temperatura massima uso continuo <i>Max working temperature</i>	50 °C / 120 °F	60° / 140 °F	60° / 140 °F
Raccordo in ingresso <i>Incoming fitting</i>	Girevole / Swivel G 1/2" F	Girevole / Swivel G 1/2" F	Girevole / Swivel G 1/2" F
Ampiezza getto acqua <i>Water jet width</i>	Regolato tramite leva: - leva completamente tirata: getto a spillo - leva rilasciata: getto a cono 60° <i>Adjustment by handle: - fully pulled lever: needle jet - lever released: 60 °cone jet</i>	Vite di regolazione per variare ampiezza cono da 0° a 60° <i>Adjustment screw ranging cone width from 0° to 60°</i>	Vite di regolazione per variare ampiezza cono da 0° a 60° <i>Adjustment screw ranging cone width from 0° to 60°</i>

PISTOLE AUTOMATICHE DI EROGAZIONE

AUTOMATIC REFUELING NOZZLE

	ART. KPE060 D	Pistola automatica erogazione gasolio 60 l/min <i>Automatic refueling nozzle for gasoline 60 l/min</i>
	ART. KPE090 D	Pistola automatica erogazione gasolio 90 l/min <i>Automatic refueling nozzle for gasoline 90 l/min</i>
	ART. KPE060 U	Pistola automatica erogazione urea 60 l/min <i>Automatic refueling nozzle for AdBlue 60 l/min</i>

ATTENZIONE: non idonee per uso con gas, benzina, olio, alcool e acqua. / **ATTENTION:** not suitable for gas, petrol, oil, alcohol and water.

Zeca si riserva il diritto di modificare i prodotti per migliorie tecniche o per necessità costruttive o commerciali.

Zeca has the right to make changes on the products for the sake of technical improvements or for any constructive or commercial requirements.

ZECA

zeca.it



010.445

ZECA S.p.A.

**Strada della Chiara, 25
10080 Feletto C.se (TO) Italia**

Tel. +39 0124 499611
Fax +39 0124 490669

info@zeca.it
export@zeca.it
italia@zeca.it