

Filter of the Multi-Fix series

Filter G1/2 5µm with PC bowl and automatic drain

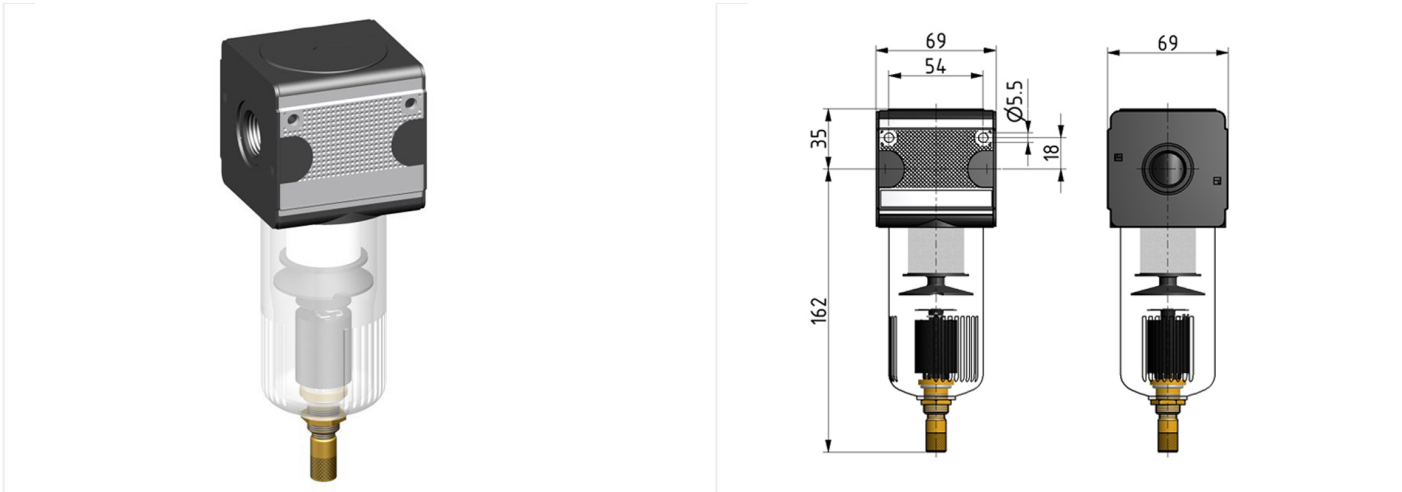

type	part-number	series	port size	flow rate	weight
F.33 AM10	9.1333.100	Multi-Fix	G 1/2	5850 l/min	0.817 kg

flow characteristic

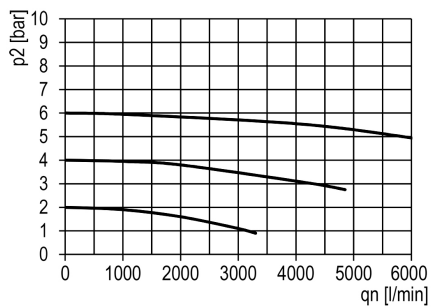

symbol

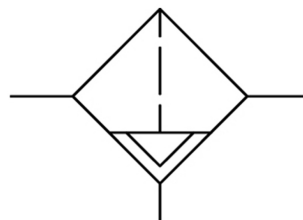

technical data

- **description:** sinter filter centrifugal principle
- **medium:** compressed air, neutral gases
- **supply pressure P1 min.:** 1,5 bar
- **supply pressure P1 max.:** 16 bar
- **temperature range:** -10°C - +60°C
- **owl:** PC
- **drain:** AM NO
- **mounting:** vertical
- **filter element:** 5 µm

accessories



- mounting bracket: [ZW.33-1](#)