

Filter regulator of the Multi-Fix series

Filter regulator G3/8 0,5-10 5µm with PC bowl, automatic drain and gauge G 50.16 R

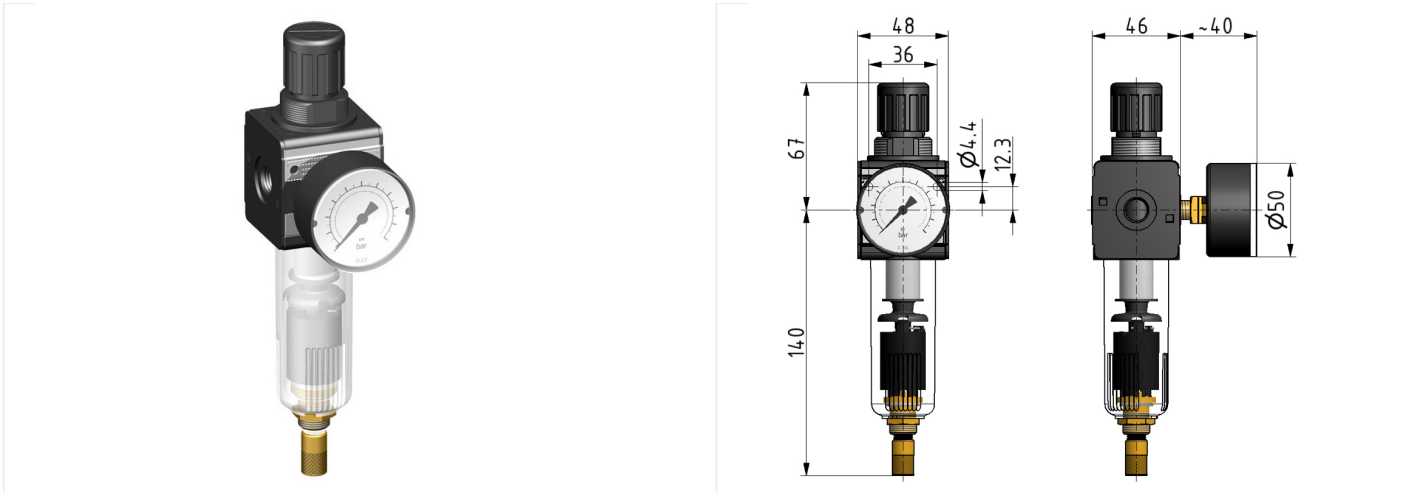

type	part-number	series	port size	flow rate	adjustment range P2 max.	weight
C.12 G AM10	9.2112.048	Multi-Fix	G 3/8	1600 l/min	10 bar	0.474 kg

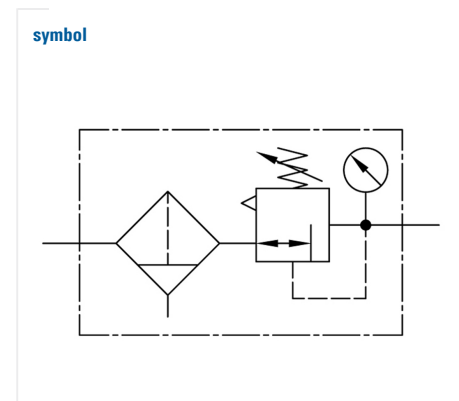
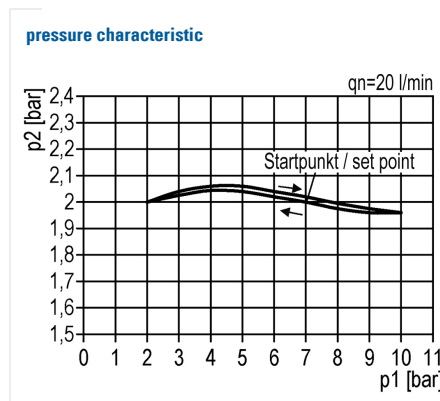
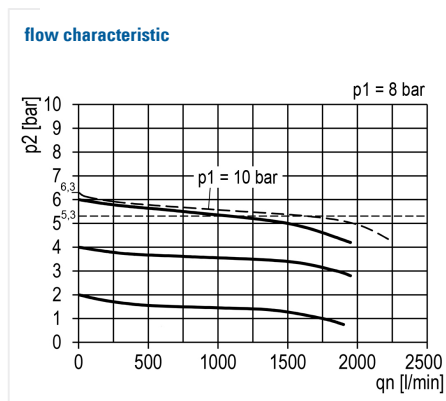

technical data

- **description:** sinter filter centrifugal principle, diaphragm-type pressure with relieving feature
- **medium:** compressed air, neutral gases
- **supply pressure P1 min.:** 1,5 bar
- **supply pressure P1 max.:** 16 bar
- **temperature range:** -10°C - +60°C
- **bowl:** PC
- **drain:** AM NO
- **mounting:** vertical
- **filter element:** 5 µm

accessories

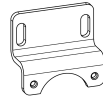

- mounting bracket: [ZW.11-1](#)

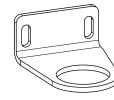

- control panel mounting: [MW.30/DR.00-34-2](#)

- lockable setting knob possible