

System extensions of the Multi-Fix series

Non return valve G3/8

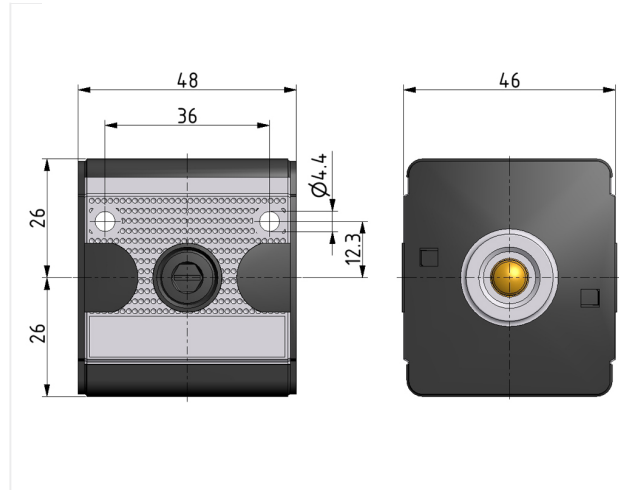

type	part-number	series	port size	weight
V.12	9.4012.100	Multi-Fix	G 3/8	0.294 kg

flow characteristic

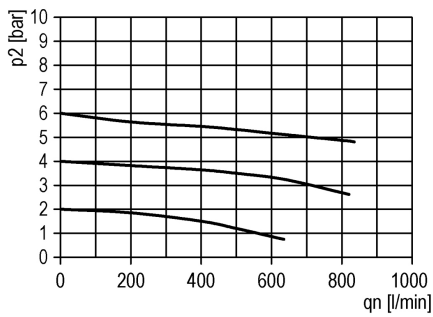

symbol

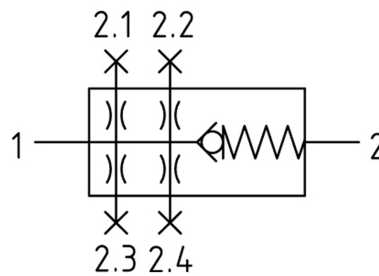

technical data

- **description:** poppet valve, spring loaded
- **medium:** compressed air, neutral gases
- **supply pressure P1 min.:** 0,1 bar
- **supply pressure P1 max.:** 16 bar
- **temperature range:** -10°C - +60°C
- **flow rate 1 => 2:** 700 l/min
- **flow rate below 1 => 2.1:** Qn = 675 l/min (at P1 = 6 bar, delta p = 1 bar)
- **flow rate top 1 => 2.2:** Qn = 675 l/min (at P1 = 6 bar, delta p = 1 bar)
- **flow rate front 1 => 2.3:** Qn = 450 l/min (at P1 = 6 bar, delta p = 1 bar)
- **flow rate back 1 => 2.4:** Qn = 450 l/min (at P1 = 6 bar, delta p = 1 bar)

accessories

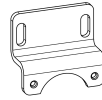

- mounting bracket: [ZW.11-1](#)