

System extensions of the Multi-Fix series

3/2 Directional control valve G1/2 electric operated 230V/50Hz

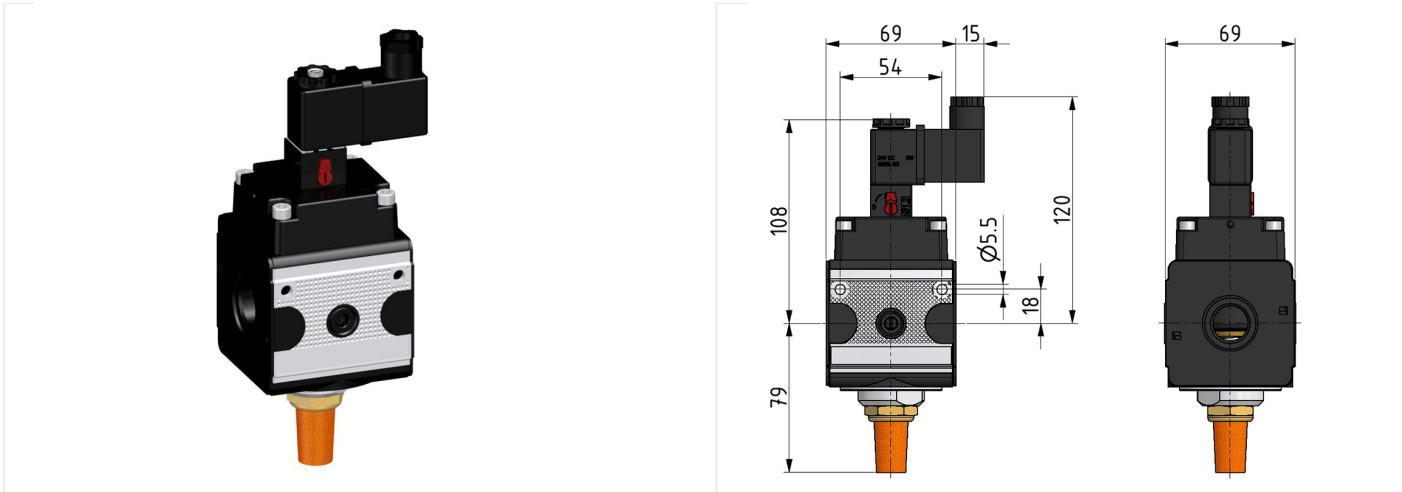

type	part-number	series	port size	flow rate	weight
S.33	9.4033.510	Multi-Fix	G 1/2	3150 l/min	1.046 kg

flow characteristic

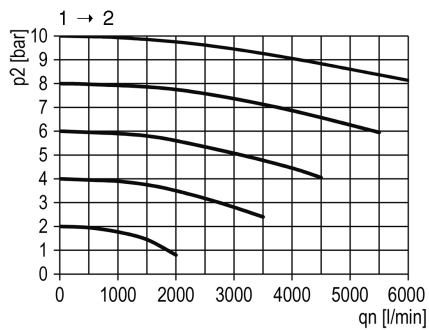

rear exhaust

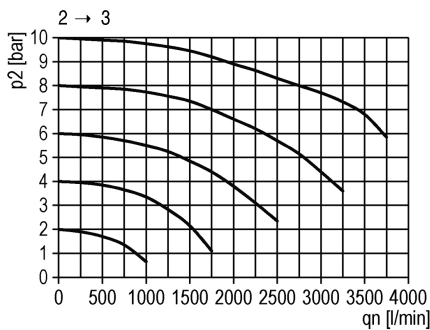

symbol

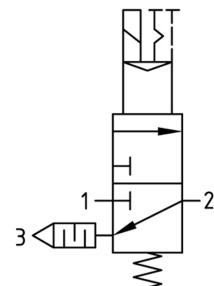

technical data

- **description:** 3/2 poppet valve
- **medium:** compressed air, neutral gases
- **supply pressure P1 min.:** 2 bar
- **supply pressure P1 max.:** 10 bar
- **temperature range:** -10°C - +60°C
- **input signal:** 230V/50Hz
- **exhaust:** G 1/2
- **relative switch on duration:** 100%
- **capacity:** 7,9 VA
- **protection class:** IP 65 according to DIN 40050
- **electrical connection:** socket coupling EN 175301-803, industrial design (included in scope of delivery)

accessories



- mounting bracket: [ZW.33-1](#)